

SUPEROFFER 2025

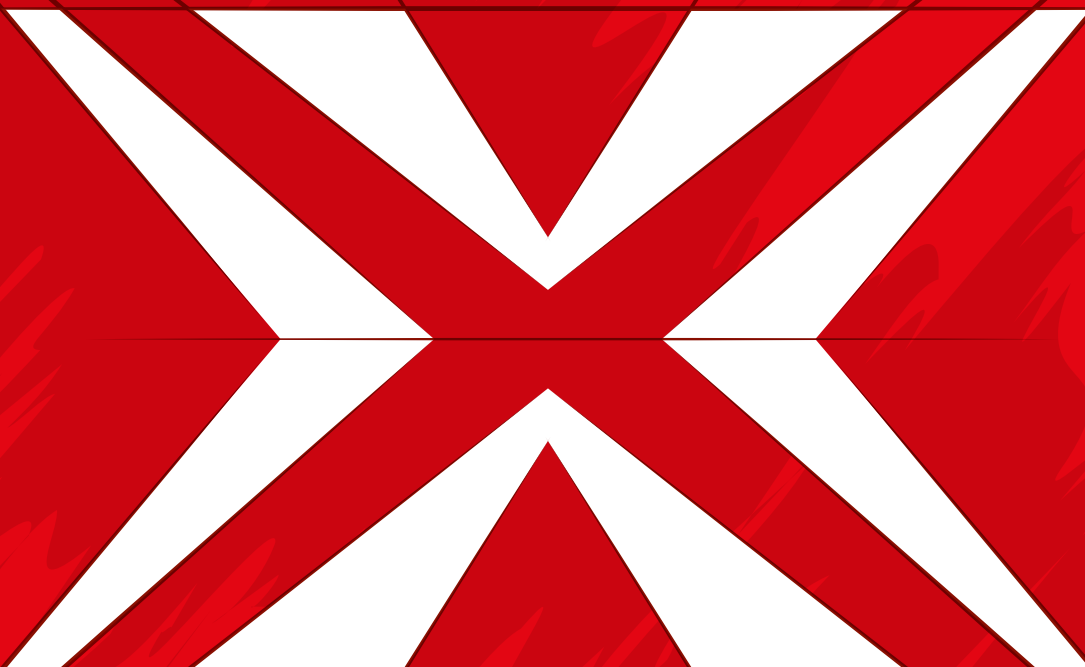

EN



XGRIP

65/2025

Valid till 31/03/2026

Index by item

New item

0		236 K Page 98	367 A SE6 Page 79	516 ST6MMEX Page 37	519 M 613AEA Page 31	824 A Page 71
001 RV Page 39	236 KE Page 98	367 SE6 Page 78	516 ST6NMA Page 35	519 M 613AEAX Page 12	831 A Page 91	
001 TRV Page 39	236 KE/C22 Page 98	373 Page 79	516 ST6NMM Page 35	519 M 613BEA Page 31	870 C Page 89	
002 JMA Page 43	237 1/2" A Page 64	373 A Page 79	516 ST6NMMEEX Page 37	519 M 613CEA Page 31	871 C Page 89	
002 JTMA Page 43	237 1/2" AK Page 64	374 G Page 80	516 ST6NPA Page 34	519 M 613CEAX Page 12	871 D Page 89	
002 JTME Page 43	237 1/4" A Page 64	374 N Page 80	516 ST6NPM Page 34	519 M 990A5MD Page 31	884 C/S6 Page 91	
007/1V Page 40	237 1/4" AK Page 64	376 Page 81	516 ST6NV Page 26	519 RBO7/3V Page 25	885 F Page 91	
007 FLV Page 41	237 1/4" SK Page 66	382 Page 81	516 ST6PA Page 34	519 RBU6/3V Page 25	889 CM Page 83	
007 MCV Page 41	237 3/8" A Page 64	382 F Page 81	516 ST6PM Page 34	519 RS6/3MA Page 32	889 GR Page 82	
007 PLV Page 41	246 RM/S2 Page 67	391 Page 90	516 ST6V Page 26	519 RS6/3MM Page 32	889 IL Page 82	
007 RV Page 42	246 R/S3 Page 67	400		519 RS6/3NMA Page 32	889 RL Page 82	
007 SV Page 42	247 AM/S3 Page 67	400 P Page 90	516 ST7V Page 26	519 RS6/3NMM Page 32	889 RP Page 83	
007 TV Page 42	247 A/S4 Page 67	421 M Page 85	516 ST8V Page 27	519 RS6/3NV Page 24	889 SP Page 83	
007 TVX Page 40	252 N/SR8 Page 61	421 P Page 85	516 STC4V Page 27	519 RS6/3V Page 24	890 N Page 85	
007 V Page 40	263/S16 Page 89	426 B/S5 Page 90	516 STS7NV Page 27	519 RS6/4MM Page 33	900	
063 W Page 73	270 Page 87	426 C/S4 Page 90	516 STS7V Page 27	519 RS6/4NMM Page 33	910 E1 1" Page 95	
074 A Page 74	270 C3 Page 87	426 D/S4 Page 90	516 STXL6MM Page 36	519 RS6/4NV Page 25	922 B1 Page 99	
076 M Page 74	272 DS Page 87	442 TA Page 76	516 STXL6NM Page 36	519 RS6/4V Page 25	922 BL1 Page 99	
076 MC Page 74	276 CE/SE8 Page 61	443 N Page 88	516 STXL6NV Page 27	519 RS7/3V Page 24	922 BP1 Page 99	
085 EX/SE3 Page 52	280 HAP/SE6 Page 49	446 DA/SE6 Page 88	516 STXL6V Page 27	519 RS8/3V Page 24	928 AC1 1/2" Page 94	
091 D/SH5 Page 46	280 HATX/SE6 Page 49	446 DT/S2 Page 89	519/127N Page 30	519 RSC4/3V Page 25	928 D1 3/4" Page 94	
091 SH5 Page 46	280 HG/SE6 Page 49	446 S28 Page 88	519/150AX Page 30	519 RSC4/4V Page 25	929 PC1 1/2" Page 92	
091 SH8 Page 46	280 HGTS/SE6 Page 49	447 T Page 84	519/252A1 Page 30	519 RSC4/5V Page 25	929 PC1/C12 Page 93	
100		280 HX/SE6 Page 10	519/276 Page 30	532 T Page 38	939 C Page 96	
115 CL/SE2 Page 90	280 HXTX/SE6 Page 11	280 HTX/SE6 Page 10	519/280HG Page 30	532 TK Page 38	939 C1 Page 96	
126 E Page 55	280 LTS/S9 Page 51	280 LTSTX/S8 Page 51	519/280HGTS Page 30	600		
127 C/SE4 Page 54	280 LTSTX/S8 Page 51	280 TK/SE6 Page 48	519/280T Page 30	601 1/2" J22 Page 62	939 C2 Page 96	
127 C/SE4S Page 54	280 TQ Page 47	280 T/SE7 Page 48	519/285A1 Page 30	601 1/4-1/2" J82 Page 63	939 E Page 97	
127 M Page 55	280 TTS/SE6 Page 48	280 TTX/SE8 Page 48	519/285B2 Page 30	601 1/4-1/2" J100 Page 63	939 N Page 97	
127 MP Page 55	280 TTX/SE8 Page 48	280 XLTS/S9 Page 51	519/285KA1 Page 30	601 1/4-1/2" JTX16 Page 62	939 W Page 97	
127 N/SE4 Page 54	280 X/S9 Page 10	280 X/S9 Page 10	519/294 Page 30	601 1/4" J34 Page 62	942 PC3 1/2" Page 92	
127 N/SE4S Page 54	285 DS8 Page 60	285 DS12 Page 60	519/322H Page 30	606 1/2" EA Page 65	942 PC3/C7 Page 93	
128 M Page 55	285 DS12 Page 60	285 J/DS7 Page 61	519/324H Page 30	606 1/4" EA Page 65	942 PD1 3/4" Page 94	
128 MP Page 55	285 J/DS12 Page 61	285 J/DS12 Page 61	519/324TX Page 30	606 1/4" SK Page 66	942 PE1 1" Page 95	
135 B Page 52	285 KA/DS8 Page 58	285 KA/DS12 Page 58	519/382F Page 30	609 1/2" EAX Page 9	943 PC1 1/2" Page 92	
135 C Page 52	285 KA/DS12 Page 58	285 KB/DS7 Page 59	519/613AEA Page 30	609 1/4" EAX Page 8	943 PC1/C12 Page 93	
146 A Page 73	285 KB/DS12 Page 59	285 KF/DS8 Page 59	519/613BEA Page 30	609 1/4" SKX Page 8	943 PC2 1/2" Page 94	
150 AX/SE3 Page 52	285 KB/DS7 Page 59	285 KF/SE5 Page 59	519/613CEA Page 30	610 1/4" EFK Page 66	988 D/S3 Page 77	
151 X Page 13	285 KF/DS12 Page 59	285 P/SE5 Page 60	519/960 Page 30	612 3/4" B Page 65	988 E/S10 Page 77	
163 Page 73	285 P/SE5 Page 60	285 SE26 Page 60	519/990A1 Page 30	612 3/4" EB Page 65	988 G/S12 Page 77	
174 CX Page 56	285 SE26 Page 60	285 X/B8 Page 5	519 M 091A Page 31	640 A Page 39	988 LA/S14 Page 77	
186 C Page 53	285 X/B12 Page 5	285 X/B12 Page 5	519 M 127N Page 31	641 T Page 39	988 MA/S19 Page 77	
187 C Page 53	294 AC Page 57	294 AC Page 57	519 M 150AX Page 31	646/5LV Page 39	988 MA/S25 Page 77	
189 AG Page 53	294 AD Page 57	294 AD Page 57	519 M 234X Page 12	660 X/B9 Page 10	995 A Page 75	
196 N Page 76	294 AG Page 57	300	519 M 235XL Page 12	664 B/S7 Page 50	995 AF Page 75	
196 NR Page 76	322 SH7 Page 46	322 SH7 Page 46	519 M 252 Page 31	664 S25 Page 50	995 CA Page 75	
200		322 SH10 Page 46	516 SA/CA Page 17	692 J32 Page 50	995 LA Page 75	
200 S Page 76	322 SH10 Page 46	324 SH5 Page 45	516 SA/CAP Page 17	692 J49 Page 50	1000	
207 D Page 72	324 SH5 Page 45	324 SH8 Page 45	516 SA/CL Page 17	692 J100 Page 51	1613 AGM12-24 Page 84	
207 E Page 72	324 SH8 Page 45	324 SH12 Page 45	516 SA/CLP Page 17	700		
210 C Page 76	324 SH12 Page 45	324 STX/S7 Page 45	516 SA/CTA Page 15	753 KA Page 73	1785 B Page 85	
211 A Page 76	324 STX/S7 Page 45	324 XP/B16 Page 44	516 SA/CTL Page 15	800		
234 1/2" MX/SE8 Page 7	324 XP/B16 Page 44	333 K/SB10 Page 47	516 SA/PRA Page 15	810 N Page 71	1881 S22 Page 89	
234 1/2" X/SE8 Page 7	333 K/SB10 Page 47	333 K/SH8 Page 47	516 SA/PRL Page 15	810 SA Page 69	1950 C Page 86	
235 1/2" MB/C10 Page 98	333 K/SH8 Page 47	300	516 SA/STA Page 16	811 LB Page 70	2000	
235 1/2" M/C16 Page 95	322 SH7 Page 46	322 SH7 Page 46	516 SA/STAP Page 16	811 LBE Page 70	2000 A Page 86	
235 1/2" XL/C5 Page 9	322 SH10 Page 46	322 SH10 Page 46	516 SA/STL Page 16	811 NE Page 71	2550 A Page 86	
235 1/2" XL/SE12 Page 6	324 SH5 Page 45	324 SH5 Page 45	516 SA/STLP Page 16	811 SE Page 69	2550 B Page 86	
235 1/2" X/SE12 Page 6	324 SH8 Page 45	324 SH8 Page 45	516 SN Page 21	812 N Page 71	2847/3 Page 84	
235 1/4" X/SE10 Page 6	324 SH12 Page 45	324 SH12 Page 45	516 ST5V Page 26	814 A Page 91	2847 A Page 85	
235 3/4" M/C8 Page 95	324 STX/S7 Page 45	324 STX/S7 Page 45	516 ST6MA Page 35	3000		
	324 XP/B16 Page 44	324 XP/B16 Page 44	516 ST6MM Page 35	3718 C Page 100		

DISCOVER THE NEWS 2025



X-Grip range
Page 4



Portable boxes
Page 38



Maintenance
Page 76



Workbenches
Page 18



Workshop furniture
Page 14



Roller cabinets
Page 21



Assortments
Page 28



Maintenance suitcase
Page 43



Screwdrivers
Page 44



Hexagon keys and bits
Page 47



Pliers and cutting nippers
Page 52



Adjustable pliers
Page 56



Wrenches
Page 57



Ratchets and sockets
Page 62



Adapters
Page 67



Torque Control
Page 68



Electrician scissors
Page 72



Electrotechnics
Page 73



Rivet pliers
Page 75



Lighting
Page 82



Automotive
Page 84



Air tools and accessories
Page 92

**Look for
ICONIC PRODUCT:**
the tools that make the difference!



ALL THE ADVANTAGES OF X-Grip TECHNOLOGY



DAMAGED SCREWS

X-Grip allows you to work effectively on both new and heavily damaged screws: the tool will not lose its grip on the screw, enabling you to continue with your work.



TORQUE TRANSMISSION

The grip that the X-Grip profile exerts on the head of a new screw allows for the transmission of a higher tightening torque compared to standard profiles. This is a real advantage when dealing with a new screw tightened with high torque, making it difficult to loosen.



PREVENTS DAMAGE

X-Grip profiles are designed to prevent damage to the profiles of new screws. By using X-Grip tools, new screws will have a longer lifespan.

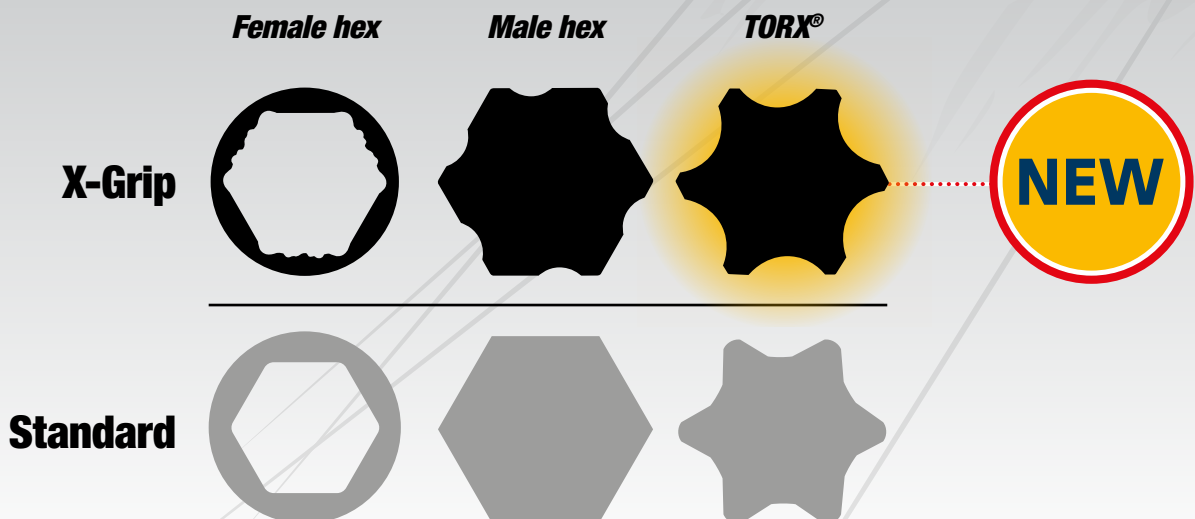

COMBINATION WRENCH 285 X

INCLINED OPEN END
angled at 15° as regards
to wrench axis.



YouTube

DOUBLE T SECTION
Excellent resistance to
flexion.

SPECIAL RING SHAPE
Ideal for operations on
nuts difficult to reach.

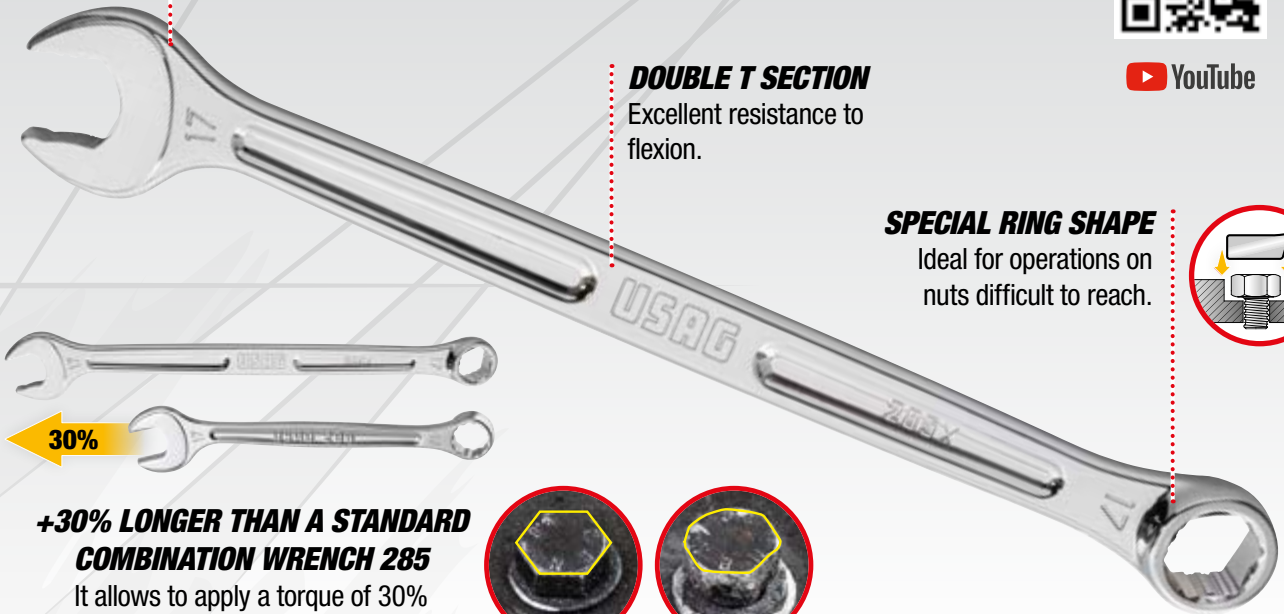
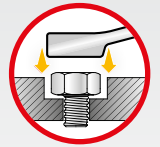

30%

**+30% LONGER THAN A STANDARD
COMBINATION WRENCH 285**

It allows to apply a torque of 30%
higher than the standard key.

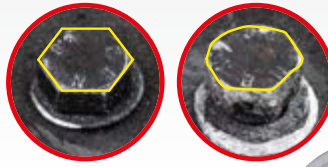

SPECIAL X-Grip PROFILE

**Effective even on heavily damaged screws.
On new screws, it transmits greater torque
and preserves the screw profile's lifespan.**



8

PIECES

285 X/B8

U02850950

**Set of 8 combination wrenches with
special profiles**

- 285 X/8-10-11-12-13-14-17-19 mm.
- Supplied in a high strength fabric roll-up bag.



8÷19 mm



12

PIECES

285 X/B12

U02850951

**Set of 12 combination wrenches with
special profiles**

- 285 X/8-9-10-11-12-13-14-15-16-17-18-19 mm.
- Supplied in a high strength fabric roll-up bag.



8÷19 mm

SOCKETS 235 X AND 235 XL



YouTube

**SPECIAL CHROME
VANADIUM STEEL**
Chrome plated finish.

NEW

SPECIAL X-Grip PROFILE

Effective even on heavily damaged screws. On new screws, it transmits greater torque and preserves the screw profile's lifespan.



235 1/2" XL/SE12
U02354101

Set of 12 hexagonal sockets with special profile

1/2"
12
PIECES

10-11-12-13-14-
15-16-17-18-19-
21-22 mm

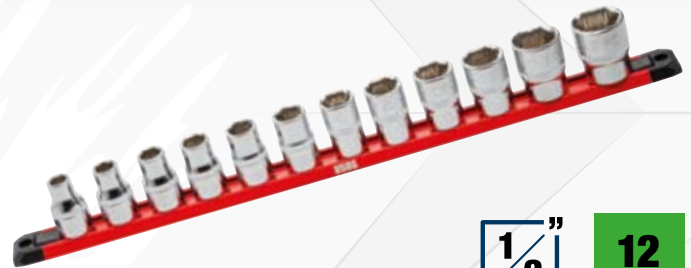

235 1/2" X/SE12
U02350501

Set of 12 hexagonal sockets with special profile

1/2"
12
PIECES

10-11-12-13-14-
15-16-17-18-19-
22-24 mm



235 1/4" X/SE10
U02350500

Set of 10 hexagonal sockets with special profile

1/4"
10
PIECES

5,5-6-7-8-9-10-
11-12-13-14 mm

MAGNETIC LOCKING SOCKET HOLDER 559 A

- Magnetic base protected by a rubber layer: not damage the surface
- 360° adjustable clips, to quickly identify the socket size



NEW

SOCKETS 234 X AND 234 MX FOR SCREWS WITH RECESSED HEXAGONS.

SPECIAL CHROME VANADIUM STEEL
Chrome plated finish.

SPECIAL CHROME VANADIUM STEEL
Chrome plated finish.

SPECIAL X-Grip PROFILE

Effective even on heavily damaged screws. On new screws, it transmits greater torque and preserves the screw profile's lifespan.



NEW



1/2" **8**
PIECES



234 1/2"MX/SE8
U02340850

Set of 8 impact socket bits with special X-Grip hex profile for hex socket screws

5-6-8-10-12-14-17-19 mm

NEW



1/2" **8**
PIECES



234 1/2"X/SE8
U02342150

Set of 8 socket bits with special X-Grip hex profile for hex socket screws

5-6-8-10-12-14-17-19 mm

THE EFFECTIVENESS OF X-GRIP. THE POWER OF IMPACTS.



SOCKETS FOR RATCHET WITH INTEGRATED BIT.



RANGE OF X-Grip SETS IN CASE

Includes hex bits, Torx bits, and X-Grip sockets.

SPECIAL X-Grip PROFILE

Effective even on heavily damaged screws.

On new screws, it transmits greater torque and preserves the screw profile's lifespan.



23
PIECES

609 1/4" SKX
U06090004

120
30
60
134 g mm

1/4"

Assortment with special hexagonal sockets and bits

- Compact bimaterial box with soft-touch covering
- Metal closing clip
- Socket size engraved inside

1/4"

DESCRIPTION	ITEM/SIZE	PCS
Reversible ratchet with extension	237 1/4" SK	2
Hexagonal sockets with special profile	235 1/4" X 6-8-10-12-13	5
Bits for slot-head screws	660 0,5x4	1
Bits for PHILLIPS® screws	660 PH 2	1
Bits for Pozidriv®- Supadriv® screws	660 PZ 2	1
Socket-holder bit	660 Q 1/4"	1
Bits for TORX® Tamper Resistant screws	660 XSTX T20-T25-T30-T40	4
Bits with special hexagonal profile	660 X 2-2,5-3-4-5-6-7-8	8



YouTube



Socket-holder



NEW



38
PIECES

609 1/4" EAX
U06090003

155
50
95
900 g mm

Assortment in bi-material case with hexagonal X-Grip sockets and bits (38 pcs)

- Compact bi-material case with soft-touch coating
- Metal latch clip
- Internal marking of contained socket sizes

DESCRIPTION	ITEM/SIZE	PCS
Hexagonal sockets with special profile X-Grip	235 1/4" X 5,5-6-7-8-9-10-11-12-13-14 mm	10
Extensions	236 1/4" 50-100	2
Reversible ratchet with sealed mechanism	237 A 1/4"	1
Universal joint	241 1/4"	1
Spinner with handle	243 1/4"	1
Bits for slot-head screws	660 0,6x4,5-1x5,5-1,2x6,5	3
Bits for PH	660 PH 1-2-3	3
Bits for PZ	660 PZ 1-2-3	3
Bits with special profile X-Grip	660 X 2-3-4-5-6	5
Special Profile TORX® Tamper Resistant	660 XSTX T10-T15-T20-T25-T27-T30-T40	7
Bit-holder sockets	660 Q 1/4"	1
Socket-holder bit	684 1/4"-1/4"	1



NEW

8-10-11-12-13-14-15-16-17-18-
19-21-22-24-27-30-32 mm



STEEL HANDLE

The extension included in the set becomes the carrying handle.



System that allows you to always keep track of the contents of the set.



Internal marking of the contained sockets.

21
PIECES

609 1/2" EAX
U06090027

3,7 kg 335 mm 55 mm 180 mm

1/2"

Assortment in bi-material case with hexagonal X-Grip sockets

- Bi-material case with soft-touch coating
- Metal latch clip
- Internal marking of contained socket sizes becomes the carrying handle
- Modularity: the case has the dimensions of a tool module and can be housed in the H60 mm drawers of trolleys

DESCRIPTION	ITEM/SIZE	PCS
Hexagonal sockets with special profile	235 1/2" X 8-10-11-12-13-14-15-16-17-18-19-21-22-24-27-30-32 mm	17
Extensions	236 1/2" 125-200	2
Reversible ratchet certified IP51	237 A 1/2"	1
Universal joint	241 1/2"	1



NEW

15-17-19-21-22 mm

5
PIECES

235 1/2" XL/C5
U02353900

1 kg 180 mm 44 mm 115 mm

1/2"

Assortment in bi-material case with long sockets featuring special X-Grip hex opening

- Compact bi-material case with soft-touch coating
- Metal latch clip
- Internal marking of contained socket sizes



SPECIAL X-Grip PROFILE

Effective even on heavily damaged screws. On new screws, it transmits greater torque and preserves the screw profile's lifespan.

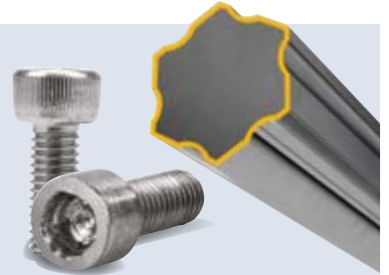

6

PIECES

280 HX/SE6

U02802460

Set of 6 angled hexagon keys with special profiles and bimaterial handgrip

- 280 HX/2,5-3-4-5-6-8 mm.
- Ergonomic bimaterial handgrip with anti-slip coating
- Design studied for a safe grip during operations
- Highly alloyed special steel
- Zinc phosphate plated for high corrosion resistance



YouTube

9

PIECES

280 X/S9

U02800485

Set of 9 angled hexagon keys with special profiles

- 280 X/1,5-2-2,5-3-4-5-6-8-10 mm.
- It allows you to work on damaged screws even at an angle of 25°
- Highly alloyed special steel
- Zinc phosphate plated for high corrosion resistance
- Supplied with plastic holder



YouTube



9

PIECES

660 X/B9

U06600100

↔ 110
↓ 20
mm ↗ 105

Set of bits with special profile

- Special hexagonal profile X-Grip: perfect grip on new or damaged hexagons recessed, up to 92%
- Special steel with phosphated finish
- Including 1/4-1/4" bit holding socket
- Supplied in a compact fabric pouch



YouTube



2-2,5-3-4-5-6-7-8 mm

1/4 Bit-holding socket

DESCRIPTION	ITEM/SIZE	PCS
Bits with special hexagonal profile	660 X 2-2,5-3-4-5-6-7-8	8
Bit-holding socket	684 1/4	1

280 HXTX MALE KEYS

ALL THE ADVANTAGES OF X-GRIP EVEN FOR TORX® SCREWS.



ERGONOMIC BIMATERIAL HANDLE

SPECIAL X-Grip PROFILE

Effective even on heavily damaged screws.

On new screws, it transmits greater torque and preserves the screw profile's lifespan.

TORX®

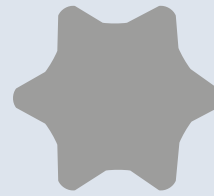

X-Grip

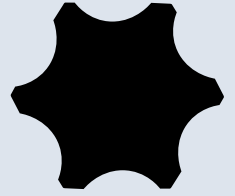

NEW

SPECIAL HIGH-ALLOY STEEL

Zinc-phosphate finish for high corrosion resistance.



T8-T10-T15-T20-T25-T30



NEW

6
PIECES

280 HXTX/SE6
U02802450

Set of 6 male keys with special TORX® X-Grip profile and bi-material handle

- Ergonomic bi-material handle with non-slip coating
- Design engineered for a secure grip during operation
- High-alloy special steel
- Zinc-phosphate finish for high corrosion resistance

X-Grip MODULES FOR YOUR ROLLER CABINET!

NEW



519 M 613CEAX

U05191068

22
PIECES

235 1/2" X 8-10-11-12-13-14-15-16-17-18-19-21-22-24-27-30-32 mm · 236 1/2" 125-250 mm · 237 A 1/2" · 240 1/2" N · 241 1/2".

NEW

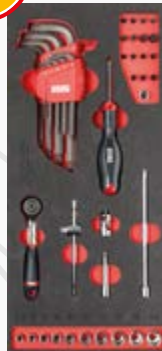

519 M 613AEAX

U05191069

41
PIECES

235 1/4" X 5,5-6-7-8-9-10-11-12-13-14 mm · 236 1/4" 50-100 mm · 237 A 1/4" · 240 1/2" N · 241 1/4" · 243 1/4" · 280 X/S9" · 660 X 2-2,5-3-4-5-6-7-8 mm · 660 XSTX T10-T15-T20-T25-T27-T30-T40 · 684 1/4".

NEW

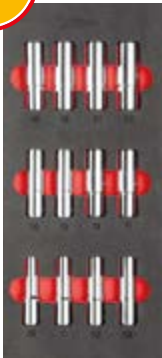

519 M 235XL

U05191067

12
PIECES

235 1/2" XL 10-11-12-13-14-15-16-17-18-19-21-22 mm.

NEW



519 M 234X

U05191017

16
PIECES

234 1/2" X 5-6-8-10-12-14-17-19 mm · 234 1/2" MX 5-6-8-10-12-14-17-19 mm.



519 M 285X

U05191063

12
PIECES

285 X 8-9-10-11-12-13-14-15-16-17-18-19 mm.



519 M 280HX

U05191064

6
PIECES

280 HX 2,5-3-4-5-6-8 mm.

NEW



519 M 280HXTX

U05191066

6
PIECES

280 HXTX T8-T10-T15-T20-T25-T30.



**Do you want to add more modules in your assortment?
Go to page 30**

COMBINATION PLIERS 151 X

SPECIAL JAWS FOR DAMAGED SCREWS AND THREADS.

**INDUCTION-HARDENED
CUTTING EDGES**

COMPACT HEAD
For excellent accessibility.

**ERGONOMIC
BIMATERIAL GRIP**

NEW



JAWS WITH SPECIAL INTERNAL PROFILE

*Allow a frontal grip on
diameters up to 15 mm.
Effective even with little
residual material to grip.*



NEW

151 X
U01510160

Combination pliers with special X-Grip jaws

- Jaws with special inner profile for front gripping of screws or threaded rods up to a diameter of 15 mm
- Also ideal for front gripping of small hexagons
- Effective on flat material as well, thanks to the 4 front contact points
- Side serrated groove for gripping round or hexagonal material
- Cutting edges further induction-hardened
- Compact head for excellent accessibility
- Allow cutting of soft, medium-hard, and hard metal wire
- Open hinge with forged joint
- Ergonomic bi-material handles
- Blackened finish with milled surfaces

**UNIVERSAL MULTI-GRIP
JAWS WITH
INTEGRATED CUTTER**



FURNITURE LINE START 516 PROFESSIONAL WORKSTATION



QUALITY OF START RANGE



High resistance 35 mm slides with a load capacity up to 40 kg.
Handles in high resistant ABS.

WORKTOP, STEEL OR WOOD, LARGE AND DURABLE

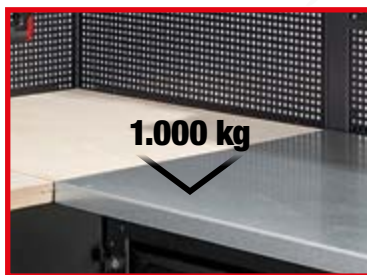

Depth: 600 mm.
Static load capacity: 1000 Kg.

COMPATIBLE WITH USAG MODULARITY

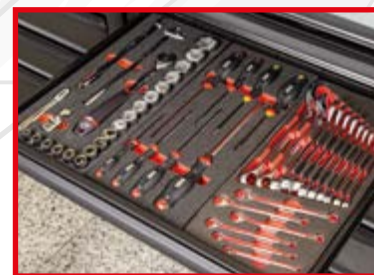

The drawers are compatible with the USAG foam modules or plastic trays system present in the Catalog.

CHOOSE YOUR IDEAL LAY-OUT

Try it now: go to start516-gb.usag.it





Complete configuration

INCLUDES: HOOKS, LED LIGHTS, POWER STRIP, AND DRAWERS ON WHEELS

DESCRIPTION	ITEM	PCS
Base unit with 6 drawers	516 SA/1T	1
Base unit with 7 drawers	516 SA1T/7	1
START roller cabinet - 6 drawers (empty)	516 SA/16T	1
Base unit with bin and paper roll holder	516 SA17T	1
Base unit with 2 doors	516 SA/2T	1
Open drawer on wheels	516 SA20T	4
Pegboard	516 SA5T	8
Pegboard with power strip (3 SCHUKO plug and 2 USB doors)	516 SA6T	2
Cabinet with 2 door	516 SA3T/2	1
Cabinet with 1 door	516 SA/3T	1
LED lamps	516 SA/12	2
Top chest with tilting door	516 SA/4T	5
Rack for power tools	516 SA4TP	1
Raising support	516 SA11T	6
Fitting kit	516 SA14T	5



516 SA/CTA
U05160299



Steel top
1.450 mm - 516 AC/1
2.175 mm - 516 AC/2
Corner kit
516 SA19T

Workshop furniture - steel top
• Supplied with 30 hooks (kit 516 SA/K1)



516 SA/CTL
U05160300



Wooden top
1.450 mm - 516 SAL/1
2.175 mm - 516 SAL/2
Corner kit
516 SA18T

Workshop furniture - wooden top
• Supplied with 30 hooks (kit 516 SA/K1)



Complete configuration

INCLUDES: HOOKS, LED LIGHTS, POWER STRIP, AND DRAWERS ON WHEELS

DESCRIPTION	ITEM	PCS
Base unit with 7 drawers	516 SA1T/7	1
Base unit with bin and paper roll holder	516 SA17T	1
Pegboard	516 SA5T	5
Pegboard with power strip (3 SCHUKO plug and 2 USB doors)	516 SA6T	1
Top chest with tilting door	516 SA/4T	3
Cabinet with 2 door	516 SA3T/2	1
START roller cabinet - 6 drawers (empty)	516 SA/16T	1
Rack for power tools	516 SA4TP	1
Open drawer on wheels	516 SA20T	2
LED lamps	516 SA/12	2
Fitting kit	516 SA14T	3
Raising support	516 SA11T	3



516 SA/PRA
U05160295



Steel top
2.175 mm - 516 AC/2

Workshop furniture - steel top
• Supplied with 30 hooks (kit 516 SA/K1)



516 SA/PRL
U05160296

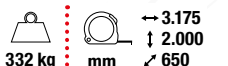

Wooden top
2.175 mm - 516 SAL/2

Workshop furniture - wooden top
• Supplied with 30 hooks (kit 516 SA/K1)



CHOOSE YOUR

Try it now: go to



Complete configuration

INCLUDES: HOOKS, LED LIGHTS, POWER STRIP, AND DRAWERS ON WHEELS

DESCRIPTION	ITEM	PCS
Base unit with 6 drawers	516 SA/1T	1
Base unit with 2 doors	516 SA/2T	1
Pegboard	516 SA5T	5
Pegboard with power strip (3 SCHUKO plug and 2 USB doors)	516 SA6T	1
Top chest with tilting door	516 SA/4T	3
Cabinet with 1 door	516 SA/3T	1
START roller cabinet - 6 drawers (empty)	516 SA/16T	1
Open drawer on wheels	516 SA20T	2
LED lamps	516 SA/12	2
Fitting kit	516 SA14T	3
Raising support	516 SA11T	3



516 SA/STA
U05160293



295 kg mm ↔ 2.675
↑ 2.000
↙ 650

Steel top

2.175 mm - 516 AC/2

Workshop furniture - steel top

- Supplied with 30 hooks (kit 516 SA/K1)



516 SA/STL
U05160294



284 kg mm ↔ 2.675
↑ 2.000
↙ 650

Wooden top

2.175 mm - 516 SAL/2

Workshop furniture - wooden top

- Supplied with 30 hooks (kit 516 SA/K1)



Configuration without accessories

DESCRIPTION	ITEM	PCS
Base unit with 6 drawers	516 SA/1T	1
Base unit with 2 doors	516 SA/2T	1
Pegboard	516 SA5T	6
Top chest with tilting door	516 SA/4T	3
Cabinet with 1 door	516 SA/3T	1
START roller cabinet - 6 drawers (empty)	516 SA/16T	1
Fitting kit	516 SA14T	3
Raising support	516 SA11T	3



516 SA/STAP
U05160313



288 kg mm ↔ 2.675
↑ 2.000
↙ 650

Steel top

2.175 mm - 516 AC/2

Workshop furniture - steel worktop



516 SA/STLP
U05160314



277 kg mm ↔ 2.675
↑ 2.000
↙ 650

Wooden top

2.175 mm - 516 SAL/2

Workshop furniture - wooden worktop



WORKBENCH SYSTEM 506 TOP RESISTANCE AND STABILITY



ACCESSORIES

Compatible with 516 AC line
(only 506 KA and KL models)



LARGE DRAWERS

mounted on high quality slides

2.000 kg



2000 mm



2.000 kg



2000 mm



506 KA
U05060256



Workstation with sheet steel top

- Galvanized sheet steel top (thickness 3 mm) with sides 37 mm
- Durable structure with 6 uprights
- Double fully opening drawers, with locking
- Metal sheet-steel doors with adjustable hinges
- Lower shelf included
- Possibility to hang 516 accessories in the lateral sides
- Arranged for ground fixing
- Static load capacity: 2000 kg
- Internal drawers dimension: 830x550x110 mm
- Internal compartments with doors dimension: 860x350x440 mm
- RAL 9005 painted steel
- Supplied disassembled

506 KL
U05060246

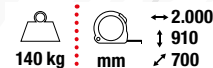

Workstation with wooden top

- Multilayer wooden top, thickness 30 mm
- Durable structure with 6 uprights
- Double fully opening drawers, with locking
- Metal sheet-steel doors with adjustable hinges
- Lower shelf included
- Possibility to hang 516 accessories in the lateral sides
- Arranged for ground fixing
- Static load capacity: 2000 kg
- Internal drawers dimension: 830x550x110 mm
- Internal compartments with doors dimension: 860x350x440 mm
- RAL 9005 painted steel
- Supplied disassembled



506 TAC

RAL 9005

STEEL

Workbench with sheet steel top

- Galvanized sheet steel top (thickness 3 mm) with sides 37 mm
- Metal sheet-steel doors uprights and lower shelf, thickness 1,2 mm
- Side holes for fixing multiple benches side by side.
- Arranged for ground fixing
- 6 uprights for size 2 m
- Gap between 2 uprights: 864 mm
- Gap between lower shelf and worktop: 525 mm
- Internal drawer dimensions:
L 1000 and L 2000: 830x550x110 mm
L 1500: 1280x550x110 mm
- Supplied disassembled

CODE	DIMENSIONS LxDxH	Weight	N° drawers
U05060154	1046x700x910 mm	65 kg	1
U05060155	1500x700x910 mm	85 kg	1
U05060156	2000x700x910 mm	110 kg	2



506 TLC

RAL 9005

WOOD

Workbench with wooden top

- Multilayer wooden top, thickness 30 mm
- Metal sheet-steel doors uprights and lower shelf, thickness 1,2 mm
- Side holes for fixing multiple benches side by side.
- Arranged for ground fixing
- 6 uprights for size 2 m
- Gap between 2 uprights: 864 mm
- Gap between lower shelf and worktop: 525 mm
- Internal drawer dimensions:
L 1000 and L 2000: 830x550x110 mm
L 1500: 1280x550x110 mm
- Supplied disassembled

CODE	DIMENSIONS LxDxH	Weight	N° drawers
U05060144	1046x700x910 mm	55 kg	1
U05060145	1500x700x910 mm	75 kg	1
U05060146	2000x700x910 mm	100 kg	2



506 KD

Divider kit for drawers 506 TC

- Compatibility:
 - 506 KD1: for drawer 506 TC1;
 - 506 KD2: for drawer 506 TC2

CODE	SIZE	Weight
U05060156Q	1	3 kg
U05060157Q	2	5 kg

Workbenches



506 TA

RAL 9005



Workbench with sheet steel top

- Galvanized sheet steel top (thickness 3 mm) with sides 37 mm
- Metal sheet-steel doors uprights and lower shelf, thickness 1,2 mm
- Side holes for fixing multiple benches side by side.
- Arranged for ground fixing
- 6 uprights for size 2 m
- Gap between 2 uprights: 864 mm
- Gap between lower shelf and worktop: 660 mm
- Supplied disassembled

CODE	DIMENSIONS LxDxH	
U05060054	1046x700x910 mm	50 kg
U05060055	1500x700x910 mm	60 kg
U05060056	2000x700x910 mm	80 kg



506 TL

RAL 9005



Workbench with wooden top

- Multilayer wooden top, thickness 30 mm
- Metal sheet-steel doors uprights and lower shelf, thickness 1,2 mm
- Side holes for fixing multiple benches side by side.
- Arranged for ground fixing
- 6 uprights for size 2 m
- Gap between 2 uprights: 864 mm
- Gap between lower shelf and worktop: 660 mm
- Supplied disassembled

CODE	DIMENSIONS LxDxH	
U05060044	1046x700x910 mm	40 kg
U05060045	1500x700x910 mm	50 kg
U05060046	2000x700x910 mm	70 kg



506 TC

RAL 9005

Drawers for workbenches

- Compatibility with 506 TA and 506 TL models
- Slides with load resistance up to 60 kg

CODE	SIZE	INT. DIMENSIONS LxDxH	
U05060154Q	1	830x550x110 mm	15 kg
U05060155Q	2	1280x550x110 mm	25 kg

NEW



506 TR U05060158Q

Wheel kit for workbenches

- Kit composed of two swiveling wheels Ø100 mm
- Non-marking rubber outer ring and polyamide core
- Integrated roller bearing
- Operating temperature from -20 to +50°C
- Maximum operating speed: 4 km/h
- The wheels reduce the maximum static load capacity of the bench on which they are assembled
- Benches 1000 and 1500: maximum static load capacity with wheels 500 kg
- Benches 2000: maximum static load capacity with wheels 900 kg
- Wheel supports in galvanized steel sheet

COMPATIBILITY WITH 506 TA AND TL BENCHES

2 pairs of wheels for 1000 and 1500 models,
3 pairs of wheels for 2000 models.

200 kg



26 kg
mm
↔ 711
↓ 810
↗ 540

516 SN U05160265

RAL
9005

3
SHELVES

Three-Shelf multi-purpose roller cabinet

- 3 shelves measuring 500x700 mm
- Shelves covered with 2 mm ABS mats
- 37 mm anti-fall edges on all 3 shelves
- Double front handle in ABS
- Four swiveling wheels (Ø 100 mm), two with brakes
- Supplied disassembled
- Maximum load capacity: 200 kg
- Structure painted in black RAL 9005

UNDER TOP UTILITY CHART

NEW



506 WORKBENCHES RANGE



START 516 WORKSHOP FURNITURE

Roller cabinets

200 kg



3
SHELVES

25 kg
mm
↔ 901
↓ 849
↙ 452



504 SR
U05040004

RAL
3020

Three-shelf utility chart

- 3 shelves 770x448 mm
- Shelves covered by 2 mm ABS mats
- 37 mm anti-fall edges on all 3 shelves
- Steel handle Ø 25 mm
- Possibility to hang 516 accessories in the lateral sides
- Two fixed and two swivelling (Ø 100 mm), one of which has a brake
- Supplied disassembled
- Maximum loading capacity: 200 Kg

504 SN
U05040014

RAL
9005

Three-shelf utility chart



Compatible with 516 line accessories



Steel tubular handle Ø 25 mm.

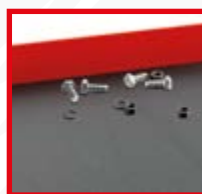

Shelves measuring 770x448 mm with a 37 mm anti-fall edge.



Oil-resistant wheels Ø 100 mm.

32 kg
mm
↔ 901
↓ 849
↙ 452

3
SHELVES

1
DRAWER

3
MODULES

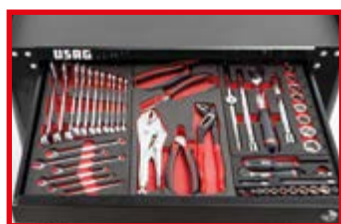

**COMPATIBLE WITH
USAG MODULARITY**

200 kg



504 SNA
U05040015

RAL
9005

Three-shelf utility chart

- 3 shelves 770x448 mm
- Shelves covered by 2 mm ABS mats
- 37 mm anti-fall edges on all 3 shelves
- Steel handle Ø 25 mm
- Possibility to hang 516 accessories in the lateral sides
- Two fixed and two swivelling (Ø 100 mm), one of which has a brake
- Drawer with slides (load capacity up to 20 kg)
- Double key supplied
- Supplied disassembled
- Maximum loading capacity: 200 Kg

NEW

3
SHELVES

42 kg
mm
↔ 1.105
↑ 875
↙ 605

300 kg



504 SRXL
U05040005

RAL
3020

Three-shelf utility cart XL

- 3 shelves measuring 600x970 mm
- Shelves covered with 2 mm ABS mats
- 37 mm anti-fall edges on all 3 shelves
- Tubular steel handle with a diameter of 25 mm
- Two swiveling wheels and two fixed wheels (Ø 125 mm), one with brake
- Supplied disassembled
- Maximum load capacity: 300 kg
- - Structure painted in red RAL 3020



Steel tubular handle Ø 25 mm.



Shelves measuring 600x970 mm with a 37 mm anti-fall edge.



Oil-resistant wheels Ø 125 mm.

NEW

25 kg
mm
↔ 760
↑ 958
↙ 560

250 kg



Compatible with bottle holder 516 AC2.

503 T
U05030002

Multi-purpose cart with folding handle

- Loading platform in galvanized sheet metal with reinforcement bars underneath
- Wide tubular steel handle, foldable onto the platform for compact transport
- Four rubber wheels Ø 125 mm, two fixed and two swiveling, one with brake
- Maximum static load capacity 250 kg
- Usable dimensions of loading platform: 760x560 mm
- Height of loading platform from the ground: 158 mm
- Total height from the ground with vertical handle: 958 mm
- Width of transport handle: 420 mm
- Handle painted in red RAL 3020



519 RACING ROLLER CABINET YOUR PREMIUM AND PROFESSIONAL WORKSHOP.



**TWO WHEELS
WITH BRAKE**

A new wider worktop
With double handle

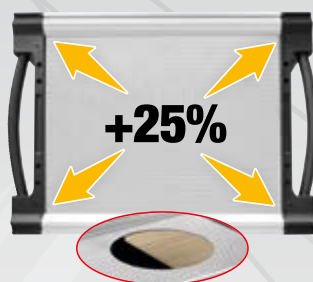

Double layer
Above: 2 mm aluminium plate.
Below: 15 mm wooden piece.



Rubber bumpers on
structure and drawers



New aluminium ergonomic handles
with selective opening



Save your time

All USAG roller cabinets are immediately ready for use, because they are supplied with the wheels already mounted on the structure



900 kg

8
DRAWERS
3
MODULES

79 kg mm 814
1005
575



900 kg

7
DRAWERS
3
MODULES

77 kg mm 814
1005
575



900 kg

6
DRAWERS

3
MODULES

75 kg mm 814
1005
575

519 RS6/3V

U05190506

RAL 3020

RACING roller cabinet (empty)

519 RS8/3V

U05190508

RAL 3020

RACING roller cabinet (empty)

- Inside dimensions:
 - 6 drawers 570x420x60 mm.
 - 2 drawers 570x420x130 mm.

519 RS7/3V

U05190507

RAL 3020

RACING roller cabinet (empty)

- Inside dimensions:
 - 5 drawers 570x420x60 mm.
 - 1 drawer 570x420x130 mm.
 - 1 drawer 570x420x200 mm.

519 RS6/3NV

U05190516

RAL 9005

RACING roller cabinet (empty)

- Inside dimensions:
 - 4 drawers 570x420x60 mm.
 - 1 drawer 570x420x130 mm.
 - 1 drawer 570x420x270 mm.

Roller cabinets



89 kg
mm
↔ 1004
↑ 1005
↙ 575

519 RS6/4V

U05190546

RAL 3020

RACING roller cabinet (empty)

519 RS6/4NV

U05190566

RAL 9005

RACING roller cabinet (empty)

- Inside dimensions:
 - 4 drawers 760x420x60 mm.
 - 1 drawer 760x420x130 mm.
 - 1 drawer 760x420x270 mm.



106 kg
mm
↔ 1194
↑ 1035
↙ 575

519 RS7/5V

U05190556

RAL 3020

RACING roller cabinet (empty)

- Inside dimensions:
 - 5 drawers 950x420x60 mm.
 - 1 drawer 950x420x130 mm.
 - 1 drawer 950x420x200 mm.



106 kg
mm
↔ 1194
↑ 1035
↙ 575

519 RB07/3V

U05190097

RAL 3020

RACING roller cabinet with side door (empty)

- Inside dimensions:
 - 5 drawers 570x420x60 mm.
 - 1 drawer 570x420x130 mm.
 - 1 drawer 570x420x200 mm.
- Side compartment: 380x400x720 mm.



6 DRAWERS
3 MODULES

128 kg
mm
↔ 1.212
↑ 1000
↙ 670

519 RBU6/3V

U05190098

RAL 3020

RAL 9005

RACING mobile workbench (empty)

- Inside dimensions:
 - 3 drawers 570x420x60 mm.
 - 2 drawers 570x420x130 mm.
 - 1 drawer 570x420x200 mm.
- Side compartment: 380x524x704 mm.



45 kg
mm
↔ 814
↑ 500
↙ 575

519 RSC4/3V

U05190534

RAL 3020

RACING drawer chest (empty)

- Inside dimensions:
 - 3 drawers: 570x420x60 mm.
 - 1 drawer: 570x420x130 mm.



51 kg
mm
↔ 1004
↑ 500
↙ 575

519 RSC4/4V

U05190544

RAL 3020

RACING drawer chest (empty)

- Inside dimensions:
 - 3 drawers: 760x420x60 mm.
 - 1 drawer: 760x420x130 mm.



60 kg
mm
↔ 1194
↑ 500
↙ 575

519 RSC4/5V

U05190554

RAL 3020

RACING drawer chest (empty)

- Inside dimensions:
 - 3 drawers: 950x420x60 mm.
 - 1 drawer: 950x420x130 mm.



YouTube

516 START ROLLER CABINET MORE RESISTANT AND RELIABLE.



New worktop 460 x 560 mm
with 15 mm sides



High resistance 35 mm slides
with a load capacity up to 40 kg



New drawer handles in high resistant
ABS with selective opening



Save your time

All USAG roller cabinets are immediately ready for use, because they are supplied with the wheels already mounted on the structure.



516 ST5V

U05160105

RAL 3020

START roller cabinet (empty)

- Inside dimensions:
 - 2 drawers 570x420x60 mm.
 - 2 drawers 570x420x130 mm.
 - 1 drawer 570x420x270 mm.

516 ST6V

U05160106

RAL 3020

START roller cabinet (empty)

516 ST6NV

U05160116

RAL 9005

START roller cabinet (empty)

- Inside dimensions:
 - 3 drawers 570x420x60 mm.
 - 2 drawers 570x420x130 mm.
 - 1 drawer 570x420x200 mm.

516 ST7V

U05160107

RAL 3020

START roller cabinet (empty)

516 ST7NV

U05160117

RAL 9005

START roller cabinet (empty)

- Inside dimensions:
 - 5 drawers 570x420x60 mm.
 - 1 drawer 570x420x130 mm.
 - 1 drawer 570x420x200 mm.



800 kg

8
DRAWERS

3
MODULES

58 kg mm ↔ 779
↓ 972
↙ 515

516 ST8V
U05160108

RAL 3020

START roller cabinet (empty)

- Inside dimensions:
 - 6 drawers 570x420x60 mm.
 - 2 drawers 570x420x130 mm.



800 kg

6
DRAWERS

4
MODULES

68 kg mm ↔ 969
↓ 972
↙ 515

516 STXL6V
U05160146

RAL 3020

START roller cabinet (empty)

- Inside dimensions:
 - 3 drawers 760x420x60 mm.
 - 2 drawers 760x420x130 mm.
 - 1 drawer 760x420x200 mm.



800 kg

6
DRAWERS

4
MODULES

68 kg mm ↔ 969
↓ 972
↙ 515

516 STXL6NV
U05160156

RAL 9005

START roller cabinet (empty)

- Inside dimensions:
 - 3 drawers 760x420x60 mm.
 - 2 drawers 760x420x130 mm.
 - 1 drawer 760x420x200 mm.

Anti-tilt system



800 kg

7
DRAWERS

3
MODULES

58 kg mm ↔ 779
↓ 972
↙ 515

516 STS7V
U05160127

RAL 3020

START roller cabinet (empty)

- Inside dimensions:
 - 5 drawers 570x420x60 mm.
 - 1 drawer 570x420x130 mm.
 - 1 drawer 570x420x200 mm.



800 kg

7
DRAWERS

3
MODULES

58 kg mm ↔ 779
↓ 972
↙ 515

516 STS7NV
U05160137

RAL 9005

START roller cabinet (empty)

- Inside dimensions:
 - 5 drawers 570x420x60 mm.
 - 1 drawer 570x420x130 mm.
 - 1 drawer 570x420x200 mm.



4
DRAWERS

3
MODULES

34 kg mm ↔ 779
↓ 467
↙ 515

516 STC4V
U05160104

RAL 3020

START drawer chest (empty)

- Inside dimensions:
 - 3 drawers: 570x420x60 mm.
 - 1 drawers: 570x420x130 mm.

BI-COLOUR FOAM MODULES



519 M 613AEA 519 M 613CEA 519 M 285A1



519 M 127C 519 M 150AX 519 MSK6



519 M 324H 519 M 324STX 519 MSK6+692 J32



519 M 990A5B 519 M 382 519 MSK6



519 M 285A1 519 M 324H 519 M 324STX



519 M 613AEA 519 M 612CLA



519 M 276C



T-HANDLE WRENCHES

8-10-13-17 mm

495 MB
U04950628

156
PIECES



Assortment for MAINTENANCE - 4 drawers

DESCRIPTION	ITEM	PCS
Hexagonal sockets, ratchet (237 A 1/4"), accessories 1/4" and bits	519 M 613AEA	46
Hexagonal sockets, ratchet (237 A 1/2") and accessories 1/2"	519 M 613CEA	23
Combination wrenches (6-7-8-9-10-11-12-13-14-15-16-17-18-19-21-22-24 mm)	519 M 285A1	17
Pliers for circlips internal and external 15÷25 and 19÷60	519 M 127C	6
Universal pliers, adjustable pliers, cutting nippers, extra-long nose pliers, lock-grip pliers	519 M 150AX	5
Screwdrivers for slot-head and PHILLIPS® screws	519 M 324H	7
Screwdrivers for TORX® Tamper Resistant screws	519 M 324STX	8
Flat square file, half-round file, round file, square file, triangular file (second cut)	519 M 990A5MD	5
Hammer for mechanics with graphite handle, mallet, pin punches, chisel and centre punch	519 M 382F	7
Assortment with bits and reversible ratchet	692 J32	32

495 MAA
U04950627

155
PIECES



Assortment for car repair - 3 drawers

DESCRIPTION	ITEM	PCS
Hexagonal sockets, ratchet (237 A 1/4"), accessories 1/4" and bits	519 M 613AEA	46
Biexagonal sockets, ratchet (237 A 1/2") and accessories 1/2"	519 M 612CLA	35
Combination wrenches (6-7-8-9-10-11-12-13-14-15-16-17-18-19-21-22-24 mm)	519 M 285A1	17
Screwdrivers for slot-head and PHILLIPS® screws	519 M 324H	7
Screwdrivers for TORX® Tamper Resistant screws	519 M 324STX	8
Pliers for circlips, combination plier, long nose pliers, T-handle wrenches with hex sockets (8-10-13-17 mm), bits set with ratchet	519 M 276C	42



519 M 612CLA 519 M 613BEA 519 M 613AEA

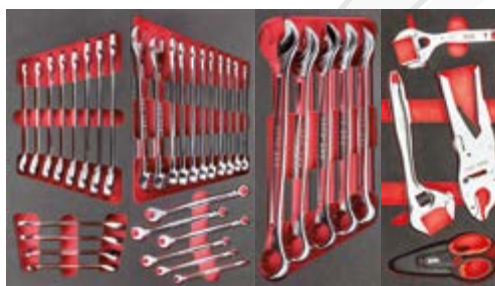

519 M 285KA 519 M 285A1 519 M 285A2 519 M 294B

302
PIECES



495 MC
U04950632

Assortment for MAINTENANCE - 4 drawers



519 M 324H 519 M 324STX 519 M 280HG 519 M 280N1



519 M 127C 519 M 150AX 519 M 382F 519 M 990A5MD

PLASTIC TRAYS



519/613AEA 519/613CEA 519 SK692V



519/285A1 519/150AX 519 SK692V



519/324H 519/324TX 519 SK692V + 692 J32



519 SK692V 519/990A1 519/382F



519/613AEA 519/613CEA 519 SK692V + 692 J32



519/324H 519/285A1 519/150AX

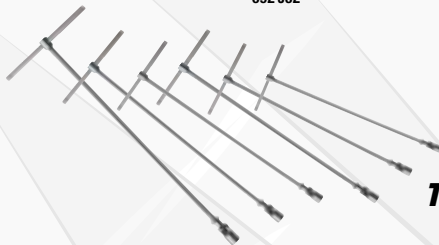

T-HANDLE WRENCHES
7-8-10-12-13-17 mm

495 PM
U04950630

157
PIECES



Assortment for MAINTENANCE - 4 drawers

DESCRIPTION	ITEM	PCS
Hexagonal sockets, ratchet (237 A 1/4"), accessories 1/4" and bits	519/613AEA	42
Hexagonal sockets, ratchet (237 A 1/2") and accessories 1/2"	519/613CEA	22
Combination wrenches (6÷24 mm) and angled keys (1,5÷10 mm)	519/285A1	25
Universal pliers, adjustable pliers, cutting nippers, extra-long nose pliers, lock-grip pliers	519/150AX	5
Screwdrivers for slot-head and PHILLIPS® screws	519/324H	10
Screwdrivers for TORX® screws	519/324TX	9
Flat square file, half-round file, round file, triangular file (second cut)	519/990A1	4
Hammers, chisels and pin punches	519/382F	8
Assortment with bits and reversible ratchet	692 J32	32

495 PA
U04950629

142
PIECES



Assortment for car repair - 2 drawers

DESCRIPTION	ITEM	PCS
Hexagonal sockets, ratchet (237 A 1/4"), accessories 1/4" and bits	519/613AEA	42
Hexagonal sockets, ratchet (237 A 1/2") and accessories 1/2"	519/613CEA	22
Screwdrivers for slot-head and PHILLIPS® screws	519/324H	10
Combination wrenches (6÷24 mm) and angled keys (1,5÷10 mm)	519/285A1	25
Universal pliers, adjustable pliers, cutting nippers, extra-long nose pliers, lock-grip pliers	519/150AX	5
T-handle wrenches with jointed hexagonal socket (7-8-10-12-13-17 mm)	276 CE	6
Assortment with Ribe bits with hole - XZN - TORX® Tamper Resistant	692 J32	32

DESCRIPTION	ITEM	PCS
Hexagonal sockets, ratchet (237 A 1/4"), accessories 1/4" and bits	519 M 613AEA	46
Hexagonal sockets, ratchet (237 A 3/8") and accessories 3/8"	519 M 613BEA	22
Hexagonal sockets, ratchet (237 A 1/2") and accessories 1/2"	519 M 612CLA	35
Reversible ratchet combination wrenches 8-9-10-11-12-13-14-15-16-17-18-19 mm	519 M 285 KA	12
Combination wrenches (6-7-8-9-10-11-12-13-14-15-16-17-18-19-21-22-24 mm)	519 M 285A1	17
Combination wrenches 27-29-30-32-34 mm	519 M 285A2	5
Adjustable wrenches, lock-grip pliers and scissor	519 M 294B	4
Screwdrivers for slot-head and PHILLIPS® screws	519 M 324H	7
Screwdrivers for TORX® Tamper Resistant screws	519 M 324STX	8
Hexagon keys with handgrip (3-4-5-6-7-8-10 mm)	519 M 280HG	7
Set of keys for TORX® screws and assortment of bits with special shapes	519 M 280N1	117
Pliers for circlips internal and external 15÷25 and 19÷60	519 M 127C	6
Universal pliers, adjustable pliers, cutting nippers, extra-long nose pliers, lock-grip pliers	519 M 150AX	5
Flat square file, half-round file, round file, square file, triangular file (second cut)	519 M 990A5B	5
Hammer for mechanics with graphite handle, mallet, pin punches, chisel and centre punch	519 M 382F	7



**CAN'T FIND YOUR
IDEAL ASSORTMENT?**

**Go now to kitplanner-gb.usag.it
and create it!**

Plastic trays



519/127N
U05190716 **4** PIECES
127 N 19÷60 · 127 PN 19÷60 ·
128 N 19÷60 · 128 PN 19÷60.



519/150AX
U05190850 **5** PIECES
133 AX 160 · 134 250 · 150 AX 180 ·
180 C 250 · 188 AX 160.



519/252A1
U05190821 **11** PIECES
252 N 6x7-8x9-10x11-12x13-14x15-16x17-
18x19-21x23-22x24-27x29-30x32.



519/280HG
U05191860 **7** PIECES
280 HG 3-4-5-6-7-8-10.



519/280HGTS
U05191861 **7** PIECES
280 HGTS 3-4-5-6-7-8-10.



519/285A1
U05190785 **25** PIECES
285 6-7-8-9-10-11-12-13-14-15-16-17-
18-19-22-24 280 S9 1,5÷10.



519/285B2
U05190823 **4** PIECES
285 27-29-30-32.



519/285KA1
U05190788 **12** PIECES
285 KA 8-9-10-11-12-13-14-15-
16-17-18-19.



519/294
U05190732 **9** PIECES
204 250 · 294 A 250 · 367 2x110-3x130-
4x145-5x165-6x180-8x200 · 981 A3.



519/322H
U05190772 **10** PIECES
322 0,5x3x75-0,8x4x100-1x5,5x125-
1,2x6,5x150-1,6x8x175 · 322 PH 0x75-1x100-
2x125 · 322 N 0,8x4x30 · 322 NPH 2x30.



519/324H
U05190763 **10** PIECES
324 0,5x3x75-0,8x4x100-1x5,5x125-
1,2x6,5x150-1,2x8x200 · 324 PH 0x75-1x75-
2x100 · 324 N 0,8x4x35 · 324 NPH 2x35.



519/324TX
U05190764 **9** PIECES
324 TX T6x50-T7x50-T8x50-T9x75 · 324 STX
T10x75-T15x75-T20x100-T25x100-T30x125.



519/382F
U05190742 **8** PIECES
362 150 · 367 2x100-3x130-4x145-
5x165 · 368 4x125 · 376 35 · 382F 500.



519/613AEA **42** PIECES
U05190784 237 A
235 1/4" EN 4-4,5-5-5,5-6-7-8-9-10-11-12-13-
14 · 236 1/4" 50-150 · 237 A 1/4" · 240 1/4" ·
241 1/4" · 243 1/4" · 692 S11 · 692 STX/S11 ·
684 1/4"-1/4".



519/613BEA **21** PIECES
U05190747 237 A
235 3/8" E 6-7-8-9-10-11-12-13-14-15-
16-17-18-19-21-22 · 236 3/8" 125-250 ·
237 A 3/8" · 240 3/8" N · 241 3/8".



519/613CEA **22** PIECES
U05190750 237 A
235 1/2" EN 10-11-12-13-14-15-16-
17-18-19-20-21-22-24-27-30-32 · 236
1/2" 125-250 · 237 A 1/2" · 240 1/2" N
· 241 1/2".



519/990A1
U05190825 **4** PIECES
990 M PA/200 · 990 M PB/200
990 M PC/200 · 990 M PE/200.



519/960
U05190753 **7** PIECES
207 A · 220 B1 · 960 · 966/20 · 974 · 978
A/200 · 981 A/3.



**Create your ideal
assortment**

*Discover the full range of
plastic modules at
usag.it or scan the QR code.*



8 PIECES **XL**
519/280T
U05190727
280 T 2-2,5-3-4-5-6-8-10.

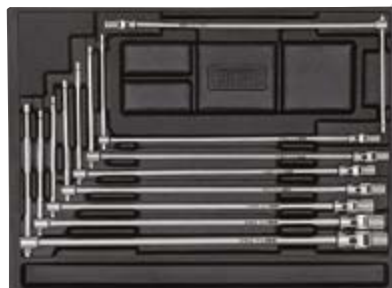

8 PIECES **XXL**
519/276
U05190725
276 CE 7-8-10-11-13-14-17-19.

Bi-colour foam modules

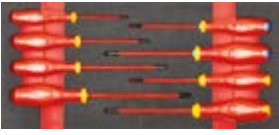

519 M 091A
U05191016 **8** PIECES
091 0,5x3x75-0,8x4x100-1x5,5x125-1,2x6,5x150 · 091 PH 1x100-2x125 · 091 PZ 1x100-2x125.



519 M 127N
U05190937 **4** PIECES
127 N 19÷60 · 127 PN 19÷60 · 128 N 19÷60 · 128 PN 19÷60.



519 M 150AX
U05190965 **5** PIECES
133 AX 160 · 134 250 · 150 AX 180 · 180 C 250 · 188 AX 160.



519 M 252
U05191072 **8** PIECES
252 N 6x7-8x9-10x11-12x13-14x15-6x17-18x19-20x22.

NEW



519 M 280HG
U05191945 **7** PIECES
280 HG 3-4-5-6-7-8-10.

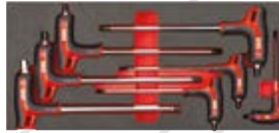

519 M 280HGTS
U05191946 **7** PIECES
280 HGTS 3-4-5-6-7-8-10.



519 M 280N1
U05191013 **117** PIECES
280 S9 1,5-2-2,5-3-4-5-6-8-10 · 280 TX/S8C T10-T15-T20-T25-T27-T30-T40-T45 · 692 J100.



519 M 283
U05191073 **8** PIECES
283 6x7-8x9-10x11-12x13-14x15-16x17-18x19-20x22.

NEW



519 M 285A1
U05190921 **17** PIECES
285 6-7-8-9-10-11-12-13-14-15-16-17-18-19-21-22-24.



519 M 285A2
U05190943 **5** PIECES
285 27-29-30-32-34.



519 M 285KA
U05190944 **12** PIECES
285 KA 8-9-10-11-12-13-14-15-16-17-18-19.



519 M 294B
U05191015 **4** PIECES
135 A 250 · 207 E · 294 AC · 294 AD 250.



519 M 324H
U05190910 **8** PIECES
324 0,5x3x75-0,8x4x100-1x5,5x125-1,2x6,5x150 · 324 PH 1x100-2x125 · 324 D 0,6x3,5x100 · 324 E 1,6x8x175.

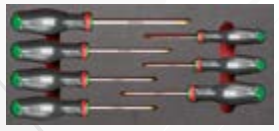

519 M 324STX
U05190911 **7** PIECES
324 STX T10x75-T15x75-T20x100-T25x100-T27x100-T30x125-T40x150.



519 M 382F
U05190926 **7** PIECES
362 175 · 367 2x100-3x130-6x180 · 368 3x100 · 376 28 · 382F 500.



519 M 613AEA
U05190940 **46** PIECES
237 A
235 1/4" EN 5,5-6-7-8-9-10-11-12-13-14 · 236 1/4" 50-100 · 237 A 1/4" · 240 1/4" · 241 1/4" · 243 1/4" · 280 LTS/S9 · 684 1/4"-1/4" · 660 0,6-1-1,6 · 660 E 3-4-5-6-8 · 660 PH 1-2-3 · 660 PZ 1-2-3 · 660 STX T15-T20-T25-T27-T30-T40.



519 M 613BEA **22** PIECES
U05190928 237 A
235 3/8" E 6-7-8-9-10-11-12-13-14-15-16-17-18-19-20-21-22 · 236 3/8" 125-250 · 237 A 3/8" · 240 3/8" N · 241 3/8".



519 M 613CEA **23** PIECES
U05190942 237 A
235 1/2" EN 8-10-11-12-13-14-15-16-17-18-19-21-22-23-24-27-30-32 · 236 1/2" 125-250 · 237 A 1/2" · 240 1/2" N · 241 1/2".



519 M 990A5MD **5** PIECES
U05191011
990 M PA/200 · 990 M PB/200 · 990 M PC/200 · 990 M PD/200 · 990 M PE/200.



Discover the full range of plastic modules at usag.it or scan the QR code.



8 PIECES **XL**

519 M 280T
U05191059
280 T 2-2,5-3-4-5-6-8-10.

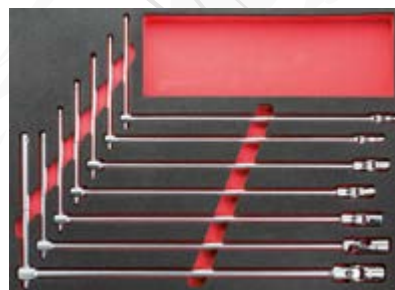

7 PIECES **XXL**

519 M 276
U05190936
276 CE 7-8-10-11-13-17-19.

Roller cabinets

CAN'T FIND
Go now to



6
DRAWERS

3
MODULES



6
DRAWERS

3
MODULES

156
PIECES

519 RS6/3MM
U05190628

RAL 3020



519 RS6/3NMM
U05191628

RAL 9005

RACING roller cabinet with assortment for MAINTENANCE 495 MB - 4 drawers

155
PIECES

519 RS6/3MA
U05190627

RAL 3020



519 RS6/3NMA
U05191627

RAL 9005

RACING roller cabinet with AUTOMOTIVE assortment 495 MAA - 3 drawers

MAINTENANCE ASSORTMENT



519 M 613AEA 519 M 613CEA 519 M 285A1



519 M 127C 519 M 150AX 519 MSK6



519 M 324H 519 M 324STX 519 MSK6+ 692 J32



519 M 990A5B 519 M 382 519 MSK6

AUTOMOTIVE ASSORTMENT



519 M 285A1 519 M 324H 519 M 324STX

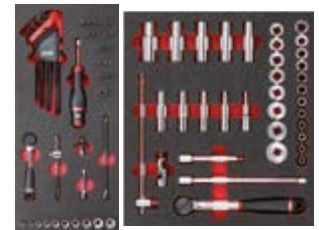

519 M 613AEA 519 M 612CLA

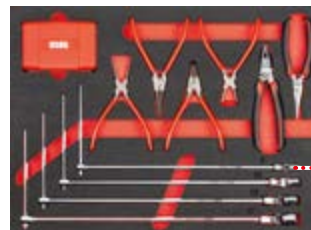

519 M 276C



T-WRENCHES WITH JOINT
8-10-13-17 mm

DESCRIPTION

DESCRIPTION	ITEM	PCS
Hexagonal sockets, ratchet (237 A 1/4"), accessories 1/4" and bits	519 M 613AEA	46
Hexagonal sockets, ratchet (237 A 1/2") and accessories 1/2"	519 M 613CEA	23
Combination wrenches (6-7-8-9-10-11-12-13-14-15-16-17-18-19-21-22-24 mm)	519 M 285A1	17
Pliers for circlips internal and external 15÷25 and 19÷60	519 M 127C	6
Universal pliers, adjustable pliers, cutting nippers, extra-long nose pliers, lock-grip pliers	519 M 150AX	5
Screwdrivers for slot-head and PHILLIPS® screws	519 M 324H	7
Screwdrivers for TORX® Tamper Resistant screws (T10-T15-T20-T25-T30-T40)	519 M 324STX	8
Flat square file, half-round file, round file, square file, triangular file (bastard cut)	519 M 990A5B	5
Hammer for mechanics with graphite handle, mallet, pin punches, chisel and centre punch	519 M 382F	7
Assortment with bits and reversible ratchet	692 J32	32

DESCRIPTION

DESCRIPTION	ITEM	PCS
Hexagonal sockets, ratchet (237 A 1/4"), accessories 1/4" and bits	519 M 613AEA	46
Bihexagonal sockets, ratchet (237 A 1/2") and accessories 1/2"	519 M 612CLA	35
Combination wrenches (6-7-8-9-10-11-12-13-14-15-16-17-18-19-21-22-24 mm)	519 M 285A1	17
Screwdrivers for slot-head and PHILLIPS® screws	519 M 324H	7
Screwdrivers for TORX® Tamper Resistant screws	519 M 324STX	8
Pliers for circlips, combination pliers, long nose pliers, T-handle wrenches with hex sockets (8-10-13-17 mm), bits set with ratchet	519 M 276C	42

Do you want only the assortment? Go to page 28

YOUR IDEAL ASSORTMENT?
Kitplanner-gb.usag.it and create it!



6
DRAWERS

4
MODULES



6
DRAWERS

4
MODULES

302
PIECES

519 RS6/4MM
U05190632

RAL
3020

RACING roller cabinet with assortment for MAINTENANCE 495 MC - 4 drawers



302
PIECES

519 RS6/4NMM
U05191632

RAL
9005

RACING roller cabinet with assortment for MAINTENANCE 495 MC - 4 drawers



MAINTENANCE ASSORTMENT



519 M 612CLA

519 M 613BEA

519 M 613AEA



519 M 285KA

519 M 285A1

519 M 285A2

519 M 294B



519 M 324H

519 M 324STX

519 M 280HG

519 M 280N1



519 M 127C

519 M 150AX

519 M 382F

519 M 990A5MD

DESCRIPTION	ITEM	PCS
Hexagonal sockets, ratchet (237 A 1/4"), accessories 1/4" and bits	519 M 613AEA	46
Hexagonal sockets, ratchet (237 A 3/8") and accessories 3/8"	519 M 613BEA	22
Bihexagonal sockets, ratchet (237 A 1/2") and accessories 1/2"	519 M 612CLA	35
Reversible ratchet combination wrenches 8-9-10-11-12-13-14-15-16-17-18-19 mm	519 M 285 KA	12
Combination wrenches (6-7-8-9-10-11-12-13-14-15-16-17-18-19-21-22-24 mm)	519 M 285A1	17
Combination wrenches 27-29-30-32-34 mm	519 M 285A2	5
Adjustable wrenches, lock-grip pliers and scissor	519 M 294B	4
Screwdrivers for slot-head and PHILLIPS® screws	519 M 324H	7

DESCRIPTION	ITEM	PCS
Screwdrivers for TORX® Tamper Resistant screws (T10-T15-T20-T25-T30-T40)	519 M 324STX	8
Hexagon keys with handgrip (3-4-5-6-7-8-10 mm)	519 M 280HG	7
Set of keys for TORX® screws and assortment of bits with special shapes	519 M 280N1	117
Pliers for circlips internal and external 15÷25 and 19÷60	519 M 127C	6
Universal pliers, adjustable pliers, cutting nippers, extra-long nose pliers, lock-grip pliers	519 M 150AX	5
Flat square file, half-round file, round file, square file, triangular file (second cut)	519 M 990A5B	5
Hammer for mechanics with graphite handle, mallet, pin punches, chisel and centre punch	519 M 382F	7

Do you want only the assortment? Go to page 28

Roller cabinets

CAN'T FIND
Go now to



6
DRAWERS

3
MODULES



6
DRAWERS

3
MODULES

157
PIECES

516 ST6PM
U05160630

RAL
3020



516 ST6NPM
U05161630

RAL
9005

START roller cabinet with MAINTENANCE assortment 495 PM - 4 drawers

142
PIECES

516 ST6PA
U05160629

RAL
3020



516 ST6NPA
U05161629

RAL
9005

START roller cabinet with AUTOMOTIVE assortment 495 PA - 2 drawers

MAINTENANCE ASSORTMENT

AUTOMOTIVE ASSORTMENT

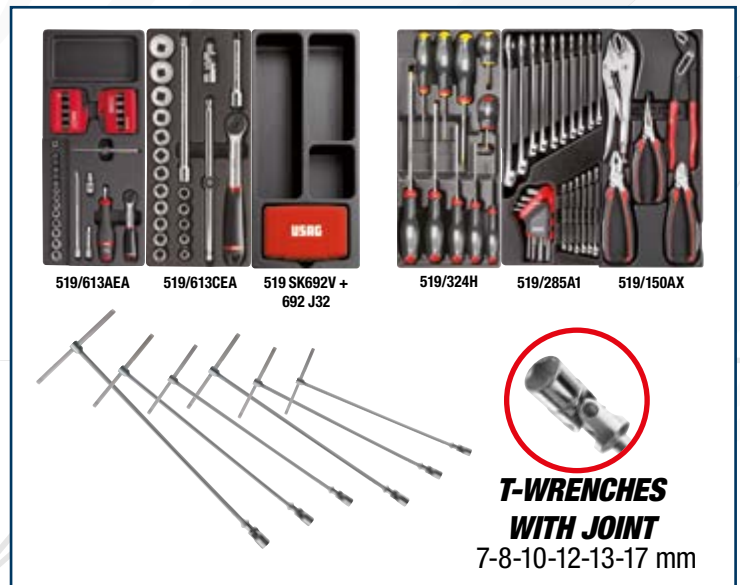
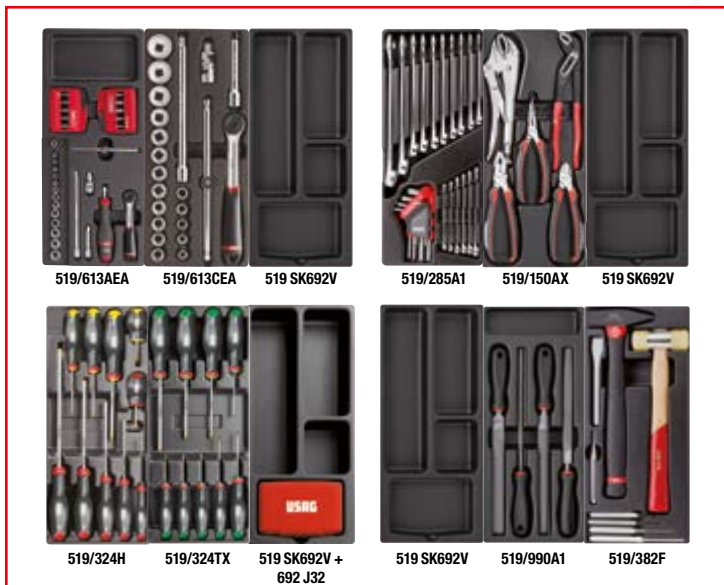

DESCRIPTION	ITEM	PCS
Hexagonal sockets, ratchet (237 A 1/4"), accessories 1/4" and bits	519/613AEA	42
Hexagonal sockets, ratchet (237 A 1/2") and accessories 1/2"	519/613CEA	22
Combination wrenches (6÷24 mm) and angled keys (1,5÷10 mm)	519/285A1	25
Universal pliers, adjustable pliers, cutting nippers, extra-long nose pliers, lock-grip pliers	519/150AX	5
Screwdrivers for slot-head and PHILLIPS® screws	519/324H	10
Screwdrivers for TORX® screws	519/324TX	9
Flat square file, half-round file, round file, triangular file (second cut)	519/990A1	4
Hammers, chisels and pin punches	519/382F	8
Assortment with bits and reversible ratchet	692 J32	32

DESCRIPTION	ITEM	PCS
Hexagonal sockets, ratchet (237 A 1/4"), accessories 1/4" and bits	519/613AEA	42
Hexagonal sockets, ratchet (237 A 1/2") and accessories 1/2"	519/613CEA	22
Screwdrivers for slot-head and PHILLIPS® screws	519/324H	10
Combination wrenches (6÷24 mm) and angled keys (1,5÷10 mm)	519/285A1	25
Universal pliers, adjustable pliers, cutting nippers, extra-long nose pliers, lock-grip pliers	519/150AX	5
T-handle wrenches with jointed hexagonal socket (7-8-10-12-13-17 mm)	276 CE	6
Assortment with bits and reversible ratchet	692 J32	32

Do you want only the assortment? Go to page 29

YOUR IDEAL ASSORTMENT?
Kitplanner-gb.usag.it and create it!



6
DRAWERS

3
MODULES

156
PIECES

516 ST6MM
U05160628

RAL
3020



516 ST6NMM
U05161628

RAL
9005

START roller cabinet with assortment for MAINTENANCE 495 MB - 4 drawers



6
DRAWERS

3
MODULES

155
PIECES

516 ST6MA
U05160627

RAL
3020



516 ST6NMA
U05161627

RAL
9005

START roller cabinet with AUTOMOTIVE assortment 495 MAA - 3 drawers

MAINTENANCE ASSORTMENT



519 M 613AEA 519 M 613CEA 519 M 285A1



519 M 127C 519 M 150AX 519 MSK6



519 M 324H 519 M 324STX 519 MSK6+
692 J32



519 M 990A5B 519 M 382 519 MSK6

AUTOMOTIVE ASSORTMENT



519 M 285A1 519 M 324H 519 M 324STX

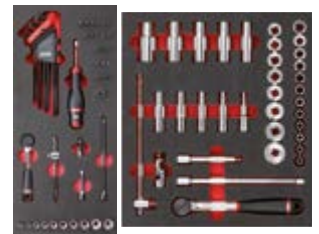

519 M 613AEA 519 M 612CLA

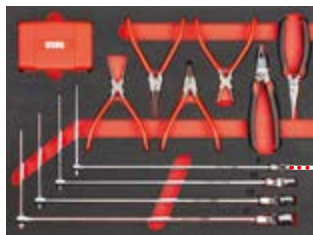

519 M 276C



T-WRENCHES WITH JOINT

8-10-13-17 mm

DESCRIPTION	ITEM	PCS
Hexagonal sockets, ratchet (237 A 1/4"), accessories 1/4" and bits	519 M 613AEA	46
Hexagonal sockets, ratchet (237 A 1/2") and accessories 1/2"	519 M 613CEA	23
Combination wrenches (6-7-8-9-10-11-12-13-14-15-16-17-18-19-21-22-24 mm)	519 M 285A1	17
Pliers for circlips internal and external 15÷25 and 19÷60	519 M 127C	6
Universal pliers, adjustable pliers, cutting nippers, extra-long nose pliers, lock-grip pliers	519 M 150AX	5
Screwdrivers for slot-head and PHILLIPS® screws	519 M 324H	7
Screwdrivers for TORX® Tamper Resistant screws	519 M 324STX	8
Flat square file, half-round file, round file, square file, triangular file (second cut)	519 M 990A5B	5
Hammer for mechanics with graphite handle, mallet, pin punches, chisel and centre punch	519 M 382F	7
Assortment with bits and reversible ratchet	692 J32	32

DESCRIPTION	ITEM	PCS
Hexagonal sockets, ratchet (237 A 1/4"), accessories 1/4" and bits	519 M 613AEA	46
Bihexagonal sockets, ratchet (237 A 1/2") and accessories 1/2"	519 M 612CLA	35
Combination wrenches (6-7-8-9-10-11-12-13-14-15-16-17-18-19-21-22-24 mm)	519 M 285A1	17
Screwdrivers for slot-head and PHILLIPS® screws	519 M 324H	7
Screwdrivers for TORX® Tamper Resistant screws	519 M 324STX	8
Pliers for circlips, combination pliers, long nose pliers, T-handle wrenches with hex sockets (8-10-13-17 mm), bits set with ratchet	519 M 276C	42

Do you want only the assortment? Go to page 28

Roller cabinets

CAN'T FIND
Go now to



6
DRAWERS

4
MODULES



6
DRAWERS

4
MODULES

302
PIECES

516 STXL6MM
U05160632

RAL
3020

START XL roller cabinet with assortment for MAINTENANCE 495 MC - 4 drawers



302
PIECES

516 STXL6NMM
U05161632

RAL
9005

START XL roller cabinet with assortment for MAINTENANCE 495 MC - 4 drawers



MAINTENANCE ASSORTMENT



519 M 612CLA

519 M 613BEA

519 M 613AEA

519 M 285KA

519 M 285A1

519 M 285A2

519 M 294B

519 M 324H

519 M 324STX

519 M 280HG

519 M 280N1

519 M 127C

519 M 150AX

519 M 382F

519 M 990A5MD

DESCRIPTION	ITEM	PCS
Hexagonal sockets, ratchet (237 A 1/4"), accessories 1/4" and bits	519 M 613AEA	46
Hexagonal sockets, ratchet (237 A 3/8") and accessories 3/8"	519 M 613BEA	22
Bihexagonal sockets, ratchet (237 A 1/2") and accessories 1/2"	519 M 612CLA	35
Reversible ratchet combination wrenches 8-9-10-11-12-13-14-15-16-17-18-19 mm	519 M 285 KA	12
Combination wrenches (6-7-8-9-10-11-12-13-14-15-16-17-18-19-21-22-24 mm)	519 M 285A1	17
Combination wrenches 27-29-30-32-34 mm	519 M 285A2	5
Adjustable wrenches, lock-grip pliers and scissor	519 M 294B	4
Screwdrivers for slot-head and PHILLIPS® screws	519 M 324H	7

DESCRIPTION	ITEM	PCS
Screwdrivers for TORX® Tamper Resistant screws	519 M 324STX	8
Hexagon keys with handgrip (3-4-5-6-7-8-10 mm)	519 M 280HG	7
Set of keys for TORX® screws and assortment of bits with special shapes	519 M 280N1	117
Pliers for circlips internal and external 15÷25 and 19÷60	519 M 127C	6
Universal pliers, adjustable pliers, cutting nippers, extra-long nose pliers, lock-grip pliers	519 M 150AX	5
Flat square file, half-round file, round file, square file, triangular file (second cut)	519 M 990A5B	5
Hammer for mechanics with graphite handle, mallet, pin punches, chisel and centre punch	519 M 382F	7

Do you want only the assortment? Go to page 28

YOUR IDEAL ASSORTMENT?
Kitplanner-gb.usag.it and create it!



6
DRAWERS

3
MODULES



6
DRAWERS

3
MODULES

264
PIECES

516 ST6MMEX
U05160634

RAL
3020

**START roller cabinet with assortment for
MAINTENANCE 495 MMEX - 4 drawers**



264
PIECES

516 ST6NMEX
U05161634

RAL
9005

**START roller cabinet with assortment for
MAINTENANCE 495 MMEX - 4 drawers**



MAINTENANCE ASSORTMENT



519 M 601



519 M 324H

519 M 324STX

519 M 280N1



519 M 127N

519 M 150AX

519 M 382F

DESCRIPTION	ITEM	PCS	DESCRIPTION	ITEM	PCS
Universal pliers, adjustable pliers, cutting nippers, extra-long nose pliers, lock-grip pliers	519 M 150AX	5	Hammer for mechanics with graphite handle, mallet, pin punches, chisel and centre punch	519 M 382F	7
Pliers for circlips internal and external 19÷60	519 M 127N	4	Adjustable wrenches, lock-grip pliers and scissor, Hexagonal sockets 1/4" 4÷14 mm - 1/2" 10÷32 mm, Long hexagonal sockets 1/4" 6÷14 mm - 1/2" 13÷22 mm, Socket bits 1/4" for PH, PZ, slot-head, hexagonal, Torx screw, Ratchet and accessories 1/4" - 1/2", Spark plug sockets 1/2" 16-21 mm, Torx sockets 1/4" - 1/2" E6÷ E24, Bits 5/16" for PH, PZ, slot-head, hexagonal, Torx, XZN screw	519 M 601	116
Set of keys for TORX® screws and assortment of bits with special shapes	519 M 280N1	117			
Screwdrivers for slot-head and PHILLIPS® screws	519 M 324H	7			
Screwdrivers for TORX® Tamper Resistant screws	519 M 324STX	8			

Do you want only the assortment? Go to page 28

PROFESSIONAL METAL CHEST 532 T

72
Liters



87
Liters

103
Liters

NEW

100 kg



532 T

RAL 3020

Professional metal chest

- Side design engineered to increase structural rigidity
- Zinc-plated steel lid hinges with a stop point at 105° opening
- Structure made of red RAL 3020 painted steel sheet

CODE	L (mm)	P (mm)	H (mm)	Weight
B U05320016	700	350	350	14 kg
C U05320017	850	350	350	16 kg
D U05320018	1000	350	350	18 kg



Zinc-plated steel latch for padlock closure (not provided)



Very large carrying handles, integrated into the side panels



Lid with internal reinforcement for maximum strength

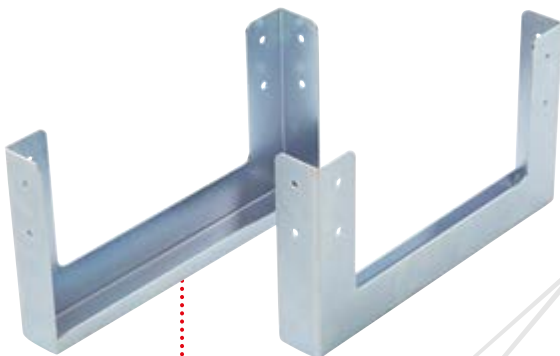

532 TK
U05320001Q

5 kg
mm
↔ 360
↓ 200
↗ 50

Set of Risers for metal chest

- Compatible with tool case 532 T
- 3 mm thick galvanized steel sheet

NEW



DESIGNED TO ALLOW THE POSSIBILITY OF TRANSPORTING THE TOOL CASE WITH A FORKLIFT OR PALLET JACK.

MAX
20 kg

4,7 kg
mm
↔ 465
↑ 352
↙ 215



001 RV
U00010004

Tool case in high thickness polypropylene (empty)

- Two inside removable panels with elastics to hold tools
- Lower compartment with mobile separators
- Double key lock

MAX
20 kg

6 kg
mm
↔ 465
↑ 352
↙ 255



001 TRV
U00010005

Tool trolley in high thickness polypropylene (empty)

- Telescopic Aluminium handle
- Wheels with integrated roll bearings



5
COMPARTMENTS

6,6 kg
mm
↔ 560
↑ 320
↙ 220



646/5LV
U06460301

Long cantilever tool box, five compartments (empty)

- Preset for padlock
- Sheet steel casing, anaphoretic process

8
COMPARTMENTS

1,5 kg
mm
↔ 422
↑ 106
↙ 335



640 A
U06400001

Organizer (empty)

- Transparent cover: contents visible
- 8 removable compartments one of which can be further divided with the 2 dividers provided

641 T

Tool box (empty)

- High resistant plastic material
- 2 compartments for small objects on the cover
- Possibility to close with a padlock (not supplied)
- Foldaway handle
- Inside removable tray

	CODE	L (mm)	P (mm)	H (mm)	🏋️
A	U06410004	16"	394	220	1,2 kg
B	U06410005	19"	486	266	2,1 kg
C	U06410006	24"	595	281	2,8 kg



Portable storage

YouTube



420 mm

MAX
11 kg

CAPACITY
34 L



All equipment on hand

007/1V
U00070001

2,5 kg
mm
↔ 420
↑ 340
↙ 240

Professional tool bag (empty)

- Model in high strength fabric
- Rigid waterproof bottom
- Inside space for tools
- Aluminium handle with covered handgrip
- 2 front pockets for small objects, 1 side pocket with Velcro closure, 1 side open pocket for quick access to contents, 4 rear pockets protected by the soft top
- 2 internal hooks for tape rule and 6 elastics to hold tools
- 1 pocket with 4 elastics to hold tools and 11 elastics for screwdrivers
- Soft top cover with Velcro



490 mm

MAX
15 kg

CAPACITY
47 L



Front pocket
for saw

007 V
U00070002

4 kg
mm
↔ 490
↑ 350
↙ 220

Professional tool bag (empty)

- Model in high strength fabric
- Rigid waterproof bottom
- Toolhoder compartments and front pocket for a saw
- Aluminium handle with covered handgrip
- Transport shoulder strap
- Soft top cover with Velcro



550 mm

MAX
18 kg

CAPACITY
33 L



Telescopic
Aluminium handle

007 TXV
U00070005

5,4 kg
mm
↔ 550
↑ 440
↙ 360

Trolley tool bag (empty)

- Model in high strength fabric
- Telescopic Aluminium handle
- 6 external pockets and 1 front pocket for a saw
- Toolhoder compartments
- Aluminium handle with covered handgrip
- Soft top cover with Velcro
- Maximum loading capacity: 18 kg



Front pocket
for saw



Wheels with
diameter 90 mm



MAX
10 kg

CAPACITY
15 L

007 MCV
U00070008

1 kg 360 mm 280 mm 190 mm

Tool bag (empty)

- Model in high strength Fabric
- Rigid waterproof bottom
- Internal toolholder compartments
- 3 front pockets with soft top protections
- 3 back pockets
- Handles with PVC cover
- Transport shoulder strap



MAX
9 kg

CAPACITY
8 L

007 FLV
U00070007

470 g 310 mm 220 mm 140 mm

Tool bag (empty)

- Model in high strength Fabric
- Frontal pocket with zipper closure
- Back pocket with velcro closure
- Rigid reinforced bottom
- Internal toolholder compartments
- Handles with PVC cover



MAX
25 kg

CAPACITY
9 L

007 PLV
U00070034

1,7 kg 450 mm 170 mm 180 mm

Bag for plumbers (empty)

- High strength fabric
- Rigid riveted bottom for higher resistance
- Inside pocket for documents
- Can hold a 1.1/2" pipe wrench
- Outside hook for tape rule
- Removable shoulder strap for extra comfort during transport
- Two top handles for better grip
- Closure with Velcro and quick release snap buckles



Portable storage

YouTube



MAX
15 kg

CAPACITY
8 L



Front opening for quick access to content



007 RV
U00070033

1,8 kg

mm

↔ 460
↓ 160
↗ 350

Bag for laptop and tools (empty)

- High strength fabric
- Rigid reinforced bottom
- The front opening allows quick access to content
- Padded compartment for notebook and documents (inside dimensions: 340x240 mm)
- 14 pockets, 2 tool straps and 1 hook for tape rule
- Removable shoulder strap for extra comfort during transport
- Closure with quick release snap buckles

MAX
12 kg

CAPACITY
30 L



Rear pocket for notebook and documents



007 SV
U00070004

3,1 kg

mm

↔ 355
↓ 225
↗ 460

Professional backpack (empty)

- High strength fabric
- Adjustable chest strap
- Padded waist straps to distribute the weight evenly
- Rigid waterproof bottom
- Inside tool-holding space
- Side and front pockets
- Inside document holder
- Padded compartment for notebook and documents (inside dimensions: 340x240 mm)
- Maximum loading capacity: 12 kg

MAX
14 kg

CAPACITY
30 L



Rear pocket for notebook and documents



007 TV
U00070006

3,5 kg

mm

↔ 350
↓ 500
↗ 200

Professional tool trolley (empty)

- Cabin size dimensions
- High strength fabric
- Inside toolholding spaces
- Front document pocket
- Side pockets with straps for long objects
- Telescopic Aluminium handle
- Wheels integrated into the structure
- Back shoulder straps
- Padded compartment for notebook and documents (inside dimensions: 340x240 mm)
- Maximum loading capacity: 14 kg



13 kg 460 mm 158 mm 385 mm

002 JMA

U00020011



181
PIECES

Case with assortment for maintenance

- Case with Aluminium section shell and metal reinforcements
- Double metal closing hinge with lock (key included)
- Three internal panels equipped with elastics to hold tools
- Base with cut-out bi-colour foam

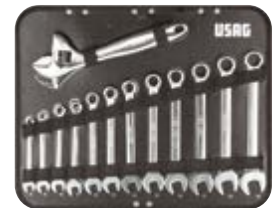

14 kg 485 mm 200 mm 377 mm

002 JTMA

U00020015



Case with assortment for maintenance

- Case with Aluminium section shell and metal reinforcements
- Double metal closing hinge with lock (key included)
- Three internal panels equipped with elastics to hold tools
- Base with cut-out bi-colour foam



14 kg 485 mm 200 mm 377 mm

002 JTME

U00020016



181
PIECES

Trolley case with assortment for electrical engineering

- Case with Aluminium section shell and metal reinforcements
- Double metal closing hinge with lock (key included)
- Three internal panels equipped with elastics to hold tools
- Base with cut-out bi-colour foam

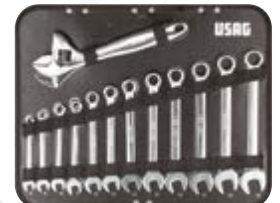



POWER ASSIST SCREWDRIVER 324 XP SPEED OF THE BATTERY, ACCURACY OF YOUR HAND



MAGNETIC BIT HOLDER
with quick release chuck.



HANDLE
ergonomic in oil and chemicals resistant rubber.

IEC 60529



LIGHT
with 5 frontal LED with automatic switch-off at 10 seconds.



AUTOMATIC LOCKING SYSTEM
of the chuck to apply the torque by hand.

CE
EN 60529

TECHNICAL CHARACTERISTICS

Vibrations (mm/s ²)	1,4
Sound power dB(A)	54
Dimensions (mm)	170x39
Weight (gr)	245



LITHIUM
3.6V - 2.0 Ah
lithium battery.

<15%

15÷74%

75÷100%



RECHARGEABLE
LED indicator of the battery charge status.
Complete recharge in 70 minutes. (IN: 5V = 3A).

POWER ASSIST SCREWDRIVER



300 RPM
0,9 Nm

ITS SPEED
Works with 300 rpm speed coming from the electric engine.

YOUR ACCURACY
Close the tightening with the accuracy of a standard screwdriver.

10 Nm

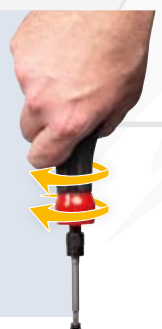

High resistance nylon



Bits holding elastics



324 XP/B16
U03240801

16
PIECES

Bag with power assist screwdriver and bits

- High resistance nylon bag with belt hook
- Bits holder elastics and USB-C cable pocket



SCREWDRIVERS 324 TOP PERFORMANCES



THREE-MATERIAL GRIP

- ❶ Outside part in polyurethane resistant to oils and chemicals.
- ❷ Body in polyamide resistant to the efforts.
- ❸ Inside part in high density polyamide for perfect coupling with the blade.

REINFORCED BLADE

Chrome Silicon Vanadium steel that allows the best mechanical resistance.

TOP PERFORMANCE TIP

Zinc finish. Perfect shape. Treatment against corrosion.

ANTI-ROLLING SHAPE

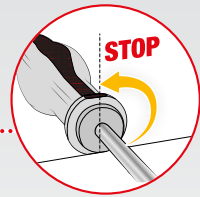

YouTube



324 SH5

U03240645

Set of 5 screwdrivers for slot-head and PHILLIPS® screws

- 324 D/0,8x4x100-1x5,5x125.
- 324 PH/0x75-1x75-2x100.

5
PIECES



324 SH8

U03240650

Set of 8 screwdrivers for slot-head and PHILLIPS® screws

- 324 D/0,4x2,5x50.
- 324/0,5x3x75-0,8x4x100-1x5,5x125-1,2x6,5x150.
- 324 PH/0x75-1x75-2x100.

8
PIECES



324 SH12

U03240651

Set of 12 screwdrivers for slot-head, PHILLIPS® and POZIDRIV®

- SUPADRIV® screws
- 324 D/0,4x2,5x50.
- 324/0,5x3x75-0,8x4x100-1x5,5x125-1,2x6,5x150.
- 324 N/1x5,5x35.
- 324 PH/0x75-1x75-2x100.
- 324 NPH/2x35.
- 324 PZ/1x75-2x100.

12
PIECES



324 STX/S7

U03240662

Set of 7 screwdrivers for TORX® Tamper Resistant screws

- 324 STX T10x75-T15x75-T20x100-T25x100-T27x100-T30x125-T40x150.

7
PIECES



SCREWDRIVERS 322 QUALITY AND CONVENIENCE.



7
PIECES



322 SH7
U03220254

Set of 7 screwdrivers for slot-head and PHILLIPS® screws

- 322 0,4x2x50-0,5x3x75-0,8x4x100-1x5,5x100-1,2x6,5x150
- 322 PH/1x100-2x125



10
PIECES



322 SH10
U03220255

Set of 10 screwdrivers for slot-head, PHILLIPS® and POZIDRIV® screws

- 322 0,4x2x50-0,5x3x75-0,8x4x100-1x5,5x100-1,2x6,5x150
- 322 PH/OX75-1x100-2x125
- 322 PZ 1X100-2X125

SCREWDRIVERS 091 1000V INSULATION - EN 60900.

USAG SLIM



5
PIECES

091 D/SH5
U00910119

Set of 5 SLIM screwdrivers for slot-head and PHILLIPS® screws - 1000 V

- 091 D/0,6x3,5x100-0,8x4x100-1x5,5x125
- 091 DPH/1x100-2x125



5
PIECES

091 SH5
U00910100

Set of 5 screwdrivers for slot-head and PHILLIPS® screws - 1000 V

- 091/0,5x3x75-0,8x4x100-1x5,5x125
- 091 PH/1x100-2x125



8
PIECES

091 SH8
U00910106

Set of 8 screwdrivers for slot-head and PHILLIPS®, POZIDRIV® - SUPADRIV® screws - 1000 V

- 091/0,5x3x75-0,8x4x100-1x5,5x125-1,2x6,5x150
- 091 PH/1x100-2x125
- 091 PZ/1x100-2x125

Hexagonal keys and bits



YouTube

8
PIECES



RATCHET SYSTEM



333 K/SH8

U03330142



COMBIDRIVE set with bits

- Delivered with 6 different bits 1/4"

DESCRIPTION	ITEM/SIZE	PCS
COMBIDRIVE handgrip with 3 functions	333 K	1
COMBIDRIVE magnetic bit-holder	333 1/4 MG	1
Bits for slot-head screws -1/4"	660/0,6x4,5-1x5,5	2
Bits for PHILLIPS® screws -1/4"	660 PH 1-2	2
Bits for hex socket screws -1/4"	660 E 3-4	2



RATCHET SYSTEM



USAG 660 bits
not included

10
PIECES



333 K/SB10

U03330143



COMBIDRIVE set in nylon bag

- Delivered with 8 different blades
- Nylon bag with belt hook

DESCRIPTION	ITEM/SIZE	PCS
COMBIDRIVE handgrip with 3 functions	333 K	1
COMBIDRIVE magnetic bit-holder	333 1/4 MG	1
Reversible COMBIDRIVE blades for slot-head screws	333 I 0,6x3,5-0,8x4/1x5,5-1,2x6,5	2
Reversible COMBIDRIVE blades for PHILLIPS® screws	333 PH 0-1/2-3	2
Reversible COMBIDRIVE blades for TORX® screws	333 TX T8-T9	4
	333 STX T10-T15/T20-T25/T30-T40	



YouTube

210 mm
length

280 TQ

U02800800

T-key bit holder

- Double magnetic bit-holder 1/4"
- Maximum capacity of the bit-holder: 6 mm hexagonal bit or T40 Torx bit
- Single end with 1/4" sockets square drive
- Special Chrome Vanadium steel
- Chrome plated finish

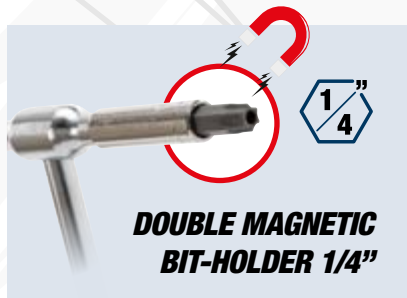

**DOUBLE MAGNETIC
BIT-HOLDER 1/4"**

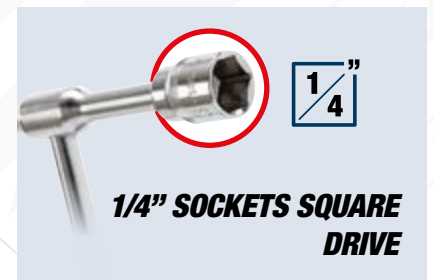

**1/4" SOCKETS SQUARE
DRIVE**

XGRIP



DISCOVER THE X-GRIP RANGE

Go to page 4



YouTube

KEY 280 T GUARANTEED SAFETY



**SPECIAL CHROME
VANADIUM STEEL**



USAG KEY



OTHER KEYS

GUARANTEED SAFETY

- + 30% resistance to torsion compared to ISO 2936 rules.
- When the breaking torque is reached, the key will deform without breaking.

FIX BAR

Maximum resistance.



**7
PIECES**



280 T/SE7

U02800903

Set of 7 T-handle hexagon keys

- 280 T/2-2,5-3-4-5-6-8 mm



**8
PIECES**



280 TTX/SE8

U02800686

Set of 8 T-handle keys for TORX® screws

- 280 TTX/T6-T7-T8-T9-T10-T15-T20-T25



**6
PIECES**



280 TTS/SE6

U02800760

Set of 6 T-handle hexagon keys with spherical head

- 280 TTS/2,5-3-4-5-6-8 mm



**6
PIECES**



280 TK/SE6

U02800020

Set of 6 T-handle hexagon keys with sliding bar

- 280 TK/2,5-3-4-5-6-8 mm



**Spherical
head**

**Sliding
bar**

ANGLED HEXAGON KEYS 280 HG WITH HANDGRIP



GUARANTEED SAFETY

- + 30% resistance to torsion compared to ISO 2936 rules.
- When the breaking torque is reached, the key will deform without breaking.

Same blade as the 280 T keys



ERGONOMIC BIMATERIAL HANDGRIP

SPECIAL CHROME VANADIUM STEEL



6 PIECES



280 HG/SE6

U02801460

Set of 6 angled hexagon keys with bimaternal handgrip

- 280 HG/2,5-3-4-5-6-8 mm

6 PIECES



280 HGTS/SE6

U02801463

Set of 6 angled hexagon keys with spherical head and bimaternal handgrip

- 280 HG/2,5-3-4-5-6-8

Spherical head



6 PIECES



280 HAP/SE6

U02800462

Set of 6 angled hexagon keys with handgrip, inch sizes

- 280 HAP 1/4-7/32-5/32-5/16-3/8-3/16

6 PIECES



280 HATX/SE6

U02800464

Set of 6 angled keys with handgrip for TORX® screws

- 280 HATX/T8-T10-T15-T20-T25-T30



Hexagonal keys and bits



32
PIECES

1/4"

280 g
mm
↔ 138
↑ 30
↘ 98



YouTube



49
PIECES

1/4"

280 g
mm
↔ 138
↑ 30
↘ 98

692 J32 U06920042

Assortment with bits and reversible ratchet - 1/4"

DESCRIPTION	SIZE	PCS
Bits for slot-head screws	4-5,5-6,5-8	4
Bits for PHILLIPS® screws	PH 1-2-3	3
Bits for POZIDRIV® screws	PZ 1-2-3	3
Bits for hex socket screws	3-4-5-6	4
Bits for TORX® screws	T8-10-15-20-20-25-25-30-40	9
Bits for TORX® Tamper Resistant screws	STX 10-15-20-25-27-30-40	7
Magnetic bit-holder adapter		1
Ratchet		1

692 J49 U06920041

Assortment with bits - 1/4"

DESCRIPTION	SIZE	PCS
Bits for slot-head screws	4-4,5-5,5-6,5-6,5-8	6
Bits for PHILLIPS® screws	PH 1-1-2-2-2-3	6
Bits for POZIDRIV® screws	PZ 1-1-2-2-2-3-3	7
Bits for hex socket screws	2-3-3-4-4-5-5-6-6	9
Bits for TORX® screws	TX 10-10-15-15-20-20-25-25-30-30	10
Bits for TORX® Tamper Resistant screws	STX 10-15-15-20-20-25-25-30-30-40	10
Magnetic bit-holder adapter		1



Colour code for quick identification of the bit



50 mm



664 S25 U06640111

Assortment with long bits for impact wrenches - 1/4"

- Plastic box

DESCRIPTION	SIZE	PCS
Bits for slot-head screws	3-4-5-6	4
Bits for PHILLIPS® screws	1-2(x2)-3(x1)	5
Bits for POZIDRIV® screws	1-2(x2)-3(x1)	5
Bits for TORX® screws	T15-T20-T25-T30-T40	5
Bits for hex socket screws	2-3-4-5-5,5	5
Magnetic bit-holder adapter		1

25
PIECES

1/4"

800 g
mm
↔ 215
↑ 45
↘ 150

664 B/S7 U06640015

Assortment with magnetic socket bits for hexagonal screws 1/4"

- Compact plastic box



7
PIECES

1/4"

5,5-6-7-8
10-12-13 mm

300 g
mm
↔ 138
↑ 30
↘ 98



Hexagonal keys and bits



900 g
 215 mm
 45 mm
 150 mm

DESCRIPTION	SIZE	PCS
Bits for slot-head screws	3-4-4,5-5-5,5-6-6,5-7-8	9
Bits for PHILLIPS® screws	PH 00-0-1-1-2-2-3-4 PZ 1-2-2-3-4	13
Bits for hex socket screws	1,5-2-2,5-3-4-5-5,5-6-7-8 mm 1/16-5/64-3/32-7/64-1/8-9/64-5/32-3/16-7/32-1/4"	20
Bits for TORX® screws	T 8-9-10-15-20-25-27-30-40-45	10
Bits for TORX® Tamper Resistant screws	STX 8-10-15-20-25-27-30-35-40	9
Tri-Wing bits	1-2-3-4	4
Spanner bits	4-6-8-10-12	5
Torq-set bits	6-8-10	3
Square bits	0-1-2-2-3	5
Clutch bits	1/8-5/32-3/16-1/4-5/16	5
Bits XZN	M5-M6-M8	3
Bits for hex socket screws with hole	2-2,5-3-4-5-6 mm - 5/64-3/32-7/64-1/8-9/64-5/32"	12
Magnetic bit-holder adapter	1/4x60mm	2

692 J100
U06920043

Assortment of bits with special shapes - 1/4"

100
 PIECES



COMPACT SUPPORTS WITH QUICK EXTRACTION SYSTEM



Watch the video



YouTube



9
 PIECES



280 LTS/S9
U02800084

Set of 9 long angled hexagon keys with spherical head

- 280 LTS/1,5-2-2,5-3-4-5-6-8-10 mm



8
 PIECES



280 LTSTX/S8
U02800078

Set of 8 long angled keys with spherical head for TORX® screws

- 280 LTSTX/T10-T15-T20-T25-T27-T30-T40-T45



9
 PIECES



280 XLTS/S9
U02800184

Set of 9 long hexagon keys with spherical head

- 280 XLTS/1,5-2-2,5-3-4-5-6-8-10 mm

Extra long model +30% of the standard 280 LTS

XGRIP



DISCOVER THE X-GRIP RANGE

Go to page 4

RANGE OF PLIERS "AX" CHROME PLATED FINISH. BIMATERIAL HANDLES.



Can cut up to 2 mm piano wire with 30% less effort in comparison to the maximum value stated on the European rules ISO5749 (cutting nippers) - ISO5746 (pliers)



CUTTING EDGES WITH INDUCTION HARDENING
for maximum efficiency in cutting the piano wire.



FULCRUM CLOSER TO THE CUTTING EDGES
to reduce effort during cutting operations.

ERGONOMIC BIMATERIAL GRIP

USAG PLIERS



- EFFORT

OTHER PRODUCTS ON THE MARKET

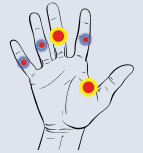

+ EFFORT

Minimum effort resulting from the studies on muscle strain made by the prestigious US Ergonomics Institute



150 AX/SE3

U01500201

**3
PIECES**

Assortment with combination pliers, extra-long half-round nose pliers and cutting nippers

- Combination pliers 150 AX 180
- Half-round extra-long nose pliers with straight jaws 133 AX 160
- Diagonal cutting nippers 188 AX 160



085 EX/SE3

U00850121

**3
PIECES**

Assortment with combination pliers, half-round nose pliers with straight jaws and diagonal cutting nippers - 1000 V

- Half-round extra-long nose pliers with straight jaws 081 EX 160
- Combination pliers 085 EX 180
- Diagonal cutting nippers 087 EX 160



1000 V

**MAX.
CAPACITY
80 mm**



135 B

U01350510

Lock-grip rack-type pliers with long jaws

- Forged jaws
- Tothing designed for a perfect grip even on round surfaces
- Patented opening system integrated in the handles
- Roller grip adjustment integrated in the handle
- 5-positions rack

**MAX.
CAPACITY
135 mm**



135 C

U01350530

Lock-grip rack-type pliers with long jaws

- Forged jaws
- Tothing designed for a perfect grip even on round surfaces
- Patented opening system integrated in the handles
- Roller grip adjustment integrated in the handle
- 5-positions rack

HIGH-LEVERAGE DIAGONAL CUTTER 189 AG 20% LESS EFFORT COMPARED TO A STANDARD DIAGONAL CUTTER

**MAX.
CUT
Ø 3 MM**



OFFSET PIVOT

Increases leverage effect, significantly reducing the effort required for cutting

189 AG
U01890200

ISO 5746

High-leverage diagonal cutter with offset pivot

- Secure grip on the wire during cutting, thanks to the jaw design
- Perfect for both demanding cuts and repetitive cutting tasks on smaller diameters
- Integrated wire gripping system at the back of the head
- Ergonomic bi-material handles
- Clear-coated finish



**HOLE FOR
PULLING WIRE**

NEW



FLUSH CUT



FOR PLASTICS

186 C

Diagonal cutting nippers with flush cutting edge for plastics

- Rounded thinned jaws
- Spring-action
- Handles sheathed in PVC

CODE L

U01860060 150 mm 22 mm

U01860061 180 mm 27 mm



**FLUSH CUT
BENT AT 45°**



FOR PLASTIC

187 C

U01870001

Diagonal cutting nipper bent at 45° with flush cutting edge for plastics

- Rounded thinned jaws
- Spring-action
- Handles sheathed in PVC
- Special Chrome Vanadium steel
- Burnished finish with polished head

**FOR THE SMOOTH, FLUSH CUTTING OF SPRUE
AS ARISES DURING INJECTION MOULDING**

Pliers with straight nose

127 N AND 128 N RANGE

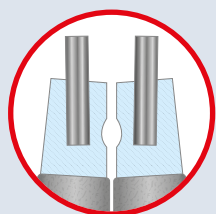

MAXIMUM RESISTANCE

Spring steel tips inserted into the nose.

127 C AND 128 C RANGE

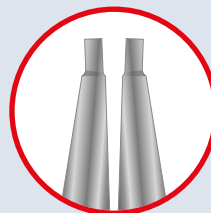

MAXIMUM ACCESSIBILITY

Nose and tip in a single body.



4
PIECES

127 N/SE4S

U01270046

10÷25 mm

Set of 4 pliers for circlips

- Pliers for internal circlips **127 N** 12÷25, **127 PN** 12÷25, pliers for external circlips **128 N** 10÷25, **128 PN** 10÷25



4
PIECES

127 C/SE4S

U01270045

10÷25 mm

Set of 4 pliers for circlips

- Pliers for internal circlips **127 C** 12÷25, **127 CP** 12÷25, pliers for external circlips **128 C** 10÷25, **128 CP** 10÷25

127 N/SE4

U01279000P

19÷60 mm

Set of 4 pliers for circlips

- Pliers for internal circlips **127 N** 19-60, **127 PN** 19-60, pliers for external circlips **128 N** 19-60, **128 PN** 19-60

127 C/SE4

U01270040

19÷60 mm

Set of 4 pliers for circlips

- Pliers for internal circlips **127 C** 19-60, **127 CP** 19-60, pliers for external circlips **128 C** 19-60, **128 CP** 19-60

RACK-TYPE PLIERS

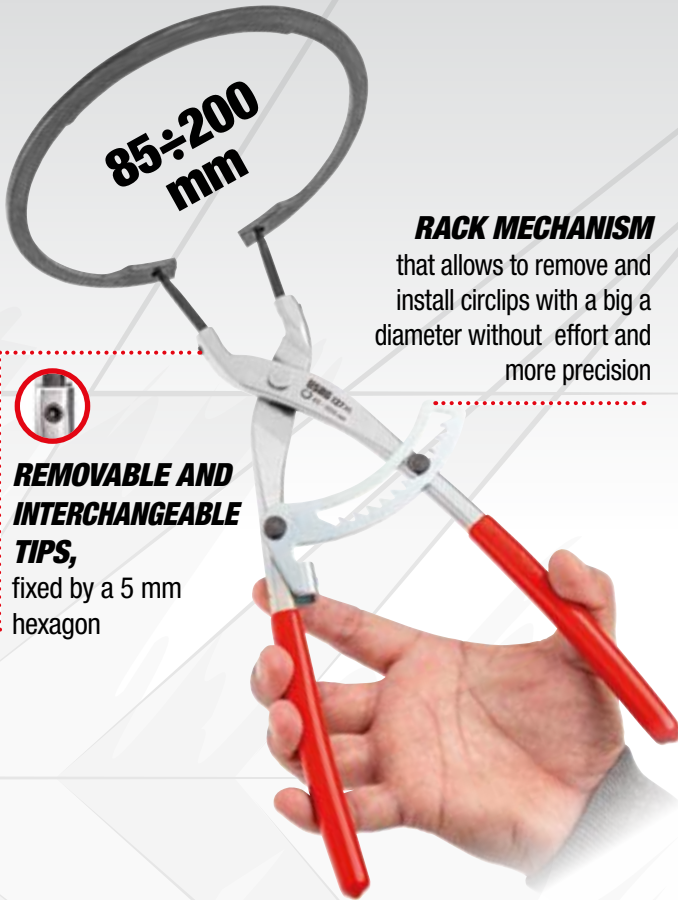

REMOVABLE AND INTERCHANGEABLE TIPS,
fixed by a 5 mm hexagon

RACK MECHANISM
that allows to remove and install circlips with a big diameter without effort and more precision



127 M
U01270051



Rack-type plier with straight nose for internal circlips with big dimensions



127 MP
U01270050



Rack-type plier with nose bent at 45° for internal circlips with big dimensions

128 M
U01280051



Rack-type plier with straight nose for external circlips with big dimensions

128 MP
U01280050



Rack-type plier with nose bent at 45° for external circlips with big dimensions

E-TYPE CIRCLIP TOOL KIT



5
PIECES

126 E
U01260001

E-type circlip tool kit

INTERCHANGEABLE BLADES

INSERT
mounting side

RELEASE
dismounting side



NEW



6-7-8-9 mm

PLIER WRENCH 174 CX PLIER AND WRENCH IN THE SAME TOOL



QUICK ADJUST CLOSING
without pushing the button.



PARALLEL JAWS
Internal design that fits perfectly
the hexagon.

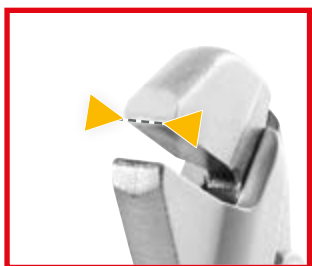

FLAT JAWS



 YouTube



METRIC SCALE

**MULTI-POSITION RACK
WITH REAR TEETH**

**HANDLES COATED
IN NON-SLIP PVC**

NEW



174 CX

Adjustable plier wrench

CODE	L	OPENING
U01740000	180 mm	43 mm
U01740001	250 mm	58 mm
U01740002	300 mm	73 mm

LARGE OPENING CAPACITY +20%



YouTube

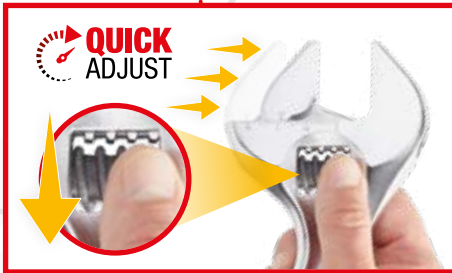

**QUICK ADJUSTMENT
BY PULLING BACK THE ROLL**

**PRECISE REGULATION
BY ROTATING THE ROLL**

294 AD

Adjustable wrenches with quick adjustment

- Quick adjustment by pulling back the roll
- Large capacity: opening +20% compared to the standard
- Double graduated scale: millimetres and inches
- Head angled at 22°
- Steel roll
- Hanging hole
- Chrome plated finish

CODE	L	OPENING
U02940011	110 mm - 4"	17 mm
U02940012	150 mm - 6"	23 mm
U02940013	200 mm - 8"	33 mm
U02940014	250 mm - 10"	38 mm
U02940015	300 mm - 12"	41 mm
U02940016	380 mm - 15"	50 mm
U02940017	460 mm - 18"	63 mm

LARGE OPENING CAPACITY +20%



YouTube



**REVERSE THE
MOVABLE JAW**
to drive an hexagonal
or a round profile

**STANDARD
POSITION**

**REVERSED
JAW**

294 AG

Reversible adjustable wrenches with handle

- In the standard position it can drive a hexagonal profile
- By reversing the movable jaw, it can drive a round profile
- Large capacity: opening +20% compared to the standard
- Double graduated scale: millimetres and inches
- Ergonomic bimaterial handle
- Head angled at 22°
- Steel roll
- Hanging hole
- Chrome plated finish

CODE	L	OPENING
U02940023	200 mm - 8"	33 mm
U02940024	250 mm - 10"	38 mm
U02940025	300 mm - 12"	41 mm

**MAX
OPENING
34 MM**



Only 150 mm

294 AC

U02940010

Short adjustable wrench

- Length reduced of 46% compared to a standard wrench
- Same jaw opening of a 12" wrench
- Lightweight and compact for optimum accessibility
- Regulation by steel roll
- Scale in millimeters on the wrench head
- Chrome plated finish

-46%



**LENGTH REDUCED OF
46% COMPARED TO A
STANDARD WRENCH**

REVERSIBLE RATCHET COMBINATION WRENCHES 285 KA WITH LOCKING RING.

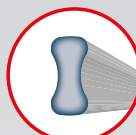

DOUBLE T SECTION
Excellent resistance to flexion.



**SPRING STEEL RING
INTEGRATED INTO THE
BIHEXAGONAL EYE**
Keeps the position on the nut during the operations.



**OPEN END WITH ANTI-SLIP
SYSTEM OF THE NUT**
Greater hold during the operations.

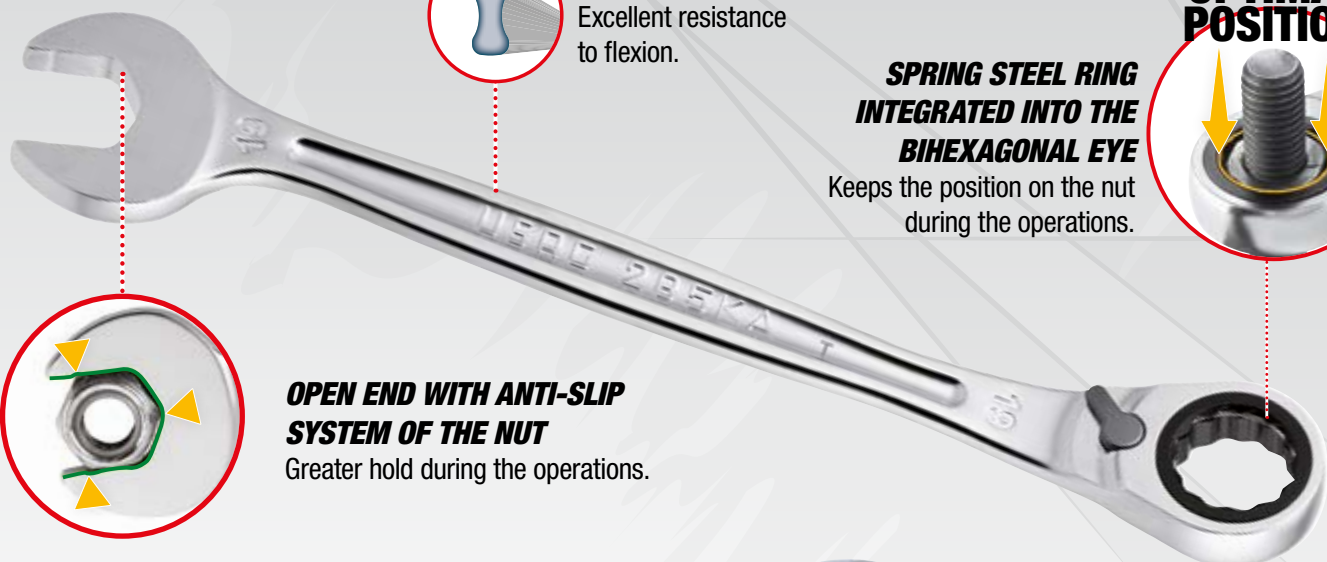

STRONG RATCHET

The ratcheting ring of USAG wrenches 285 KA exceeds static torsion tests, reaching a torque of +50% compared to the value required by ISO rules 1711-1



YouTube

8
PIECES

8÷19 mm



285 KA/DS8

U02856058

- Set of 8 reversible ratchet combination wrenches with locking ring**
- 285 KA 8-10-11-12-13-14-17-19 mm
 - Supplied with plastic holder

12
PIECES

7÷19 mm



285 KA/DS12

U02856062

- Set of 12 reversible ratchet combination wrenches with locking ring**
- 285 KA 7-8-10-11-12-13-14-15-16-17-18-19 mm
 - Supplied with plastic holder

HINGED JOINTED REVERSIBLE RATCHET COMBINATION WRENCH 285 KF

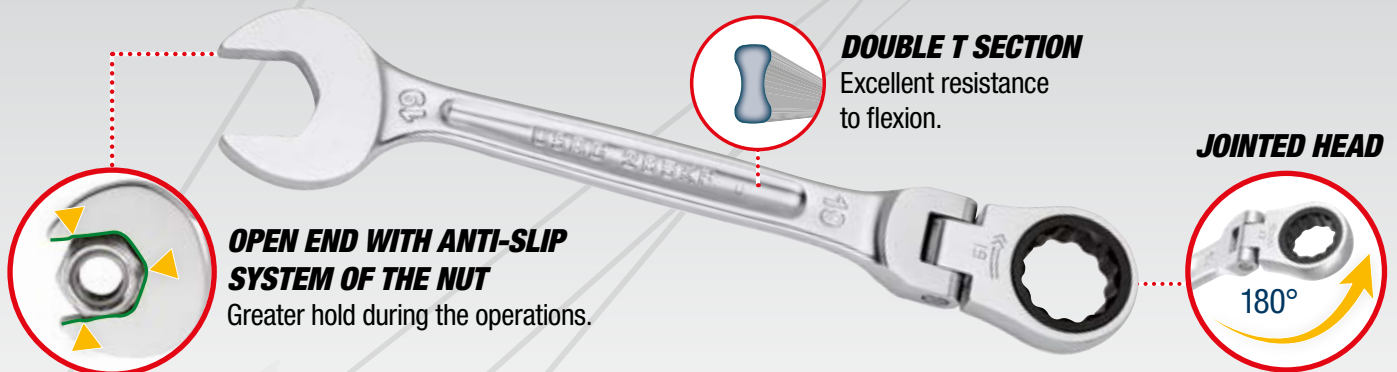

OPEN END WITH ANTI-SLIP SYSTEM OF THE NUT
Greater hold during the operations.

DOUBLE T SECTION
Excellent resistance to flexion.

JOINTED HEAD

180°



5
PIECES

8÷19 mm

285 KF/SE5
U02856160

Set of 5 hinged jointed reversible ratchet combination wrenches
• 285 KF 8-10-13-17-19 mm



8
PIECES

8÷19 mm

285 KF/DS8
U02856158

Set of 8 hinged jointed ratchet combination wrenches
• 285 KF 8-10-11-12-13-14-17-19 mm
• Supplied with plastic holder

285 KB FLAT RATCHET COMBINATION WRENCH



FLAT RATCHET HEAD
ideal for hard to reach places

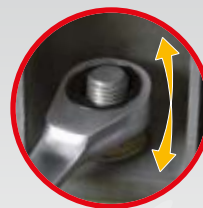

CHANGE OF ROTATION
turning the wrench 180°



7
PIECES

8÷19 mm

285 KB/DS7
U02856341

Set of 7 flat ratchet combination wrenches
• 285 KB/8-10-12-13-14-17-19 mm.
• Supplied with plastic holder



12
PIECES

8÷19 mm

285 KB/DS12
U02856342

Set of 12 flat ratchet combination wrenches
• 285 KB/8-9-10-11-12-13-14-15-16-17-19 mm.
• Supplied with plastic holder



YouTube

COMBINATION WRENCH 285 RESISTANCE AND ERGONOMIC.

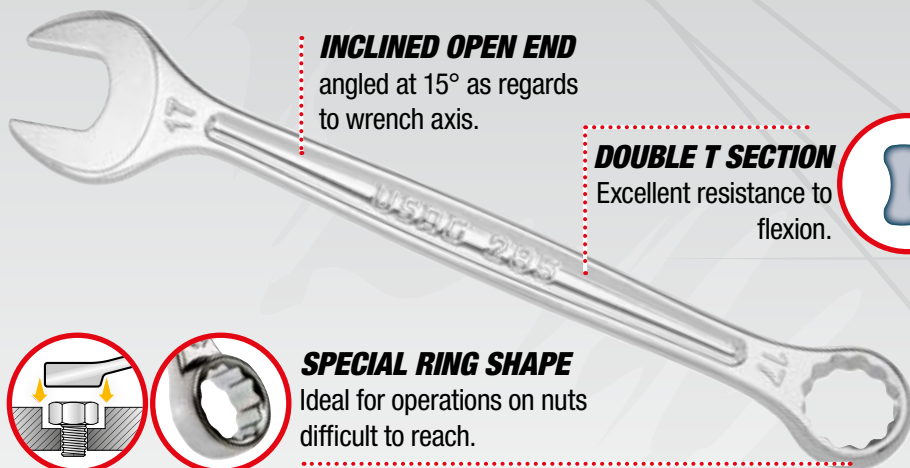

INCLINED OPEN END

angled at 15° as regards to wrench axis.

DOUBLE T SECTION

Excellent resistance to flexion.



SPECIAL RING SHAPE

Ideal for operations on nuts difficult to reach.

TOP PERFORMANCE

The open end and the bihexagonal ring of the combination wrench 285 exceed the static torsion test, reaching a torque of +50% compared to the test value required by the standard ISO 1711-1

ISO 1711-1 SAE AS 954E



8
PIECES

285 DS8

U02850863

- Set of 8 combination wrenches
- 285/8-10-11-12-13-14-17-19 mm
 - Supplied with plastic holder

8÷19 mm



12
PIECES

285 DS12

U02850864

- Set of 12 combination wrenches
- 285/7-8-10-11-12-13-14-15-16-17-18-19 mm
 - Supplied with plastic holder

7÷19 mm

SIZE
IN INCHES



5
PIECES

285 P/SE5

U02850856

- Set of 5 combination wrenches, inch sizes
- 285 P 1/4-3/8-7/16-1/2-9/16"

1/4÷9/16"



26
PIECES

285 SE26

U02850861

- Set of 26 combination wrenches
- 285/6-7-8-9-10-11-12-13-14-15-16-17-18-19-20-21-22-23-24-25-26-27-28-29-30-32 mm

6÷32 mm



DISCOVER THE X-GRIP RANGE

Go to page 4

Just **USAG** 285 J COMBINATION WRENCH



**OPEN END ANGLED
AT 15°**



**BIHEXAGONAL HEAD
BENT AT 15°**

7
PIECES

 **8÷19 mm**

285 J/DS7
U02851745

- Set of 7 combination wrenches**
- 285 J/8-10-12-13-14-17-19 mm.
 - Supplied with plastic holder

12
PIECES

 **8÷19 mm**

285 J/DS12
U02851746

- Set of 12 combination wrenches**
- 285 J/8-9-10-11-12-13-14-15-16-17-19 mm.
 - Supplied with plastic holder

8
PIECES

 **6÷22 mm**



252 N/SR8
U02520862

- Set of 8 double ended open jaw wrenches**
- 252 N/6x7-8x9-10x11-12x13-14x15-16x17-18x19-20x22 mm

8
PIECES

 **7÷19 mm**

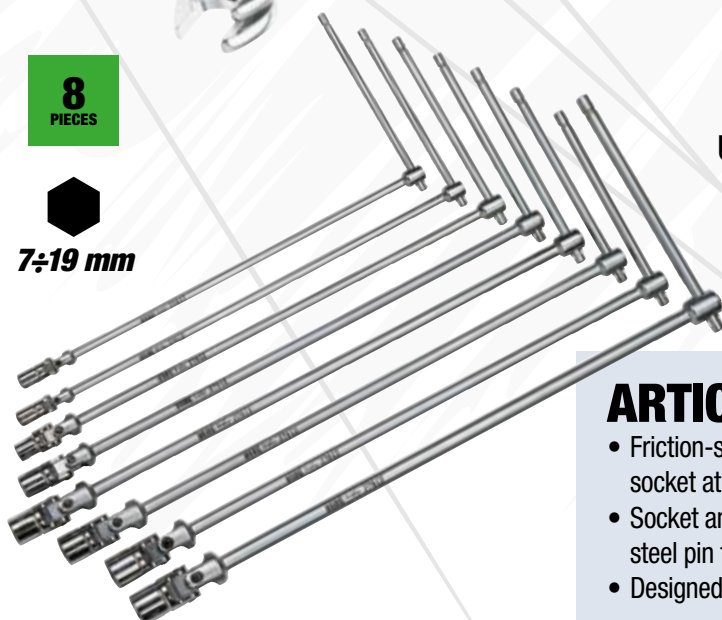

UNI 6743

276 CE/SE8
U02760484

- Set of 8 T-handle wrenches with jointed hexagonal socket**
- 276 CE/7-8-10-12-13-14-17-19 mm

ARTICULATED JOINT

- Friction-spring to allow presetting of the socket at the desired angle
- Socket and joint are fixed with a riveted steel pin for great stability.
- Designed and manufactured according to UNI 6743 rules.



Ratchets and sockets

YouTube



Just **USAG**



16
PIECES

1/
4"

1/
2"



1 kg 190 mm 58 144

601 1/4-1/2" JTX16

U06010009

Assortment with TORX® sockets in modular box

DESCRIPTION	SIZE	PCS
TORX® sockets 1/4"	E6-E7-E8-E10	4
TORX® sockets 1/2"	E12-E14-E16-E18	4
TORX® socket bits 1/4"	T10-T15-T20-T25	4
TORX® socket bits 1/2"	T30-T40-T45-T50	4



34
PIECES

1/
4"



1 kg 190 mm 58 144

601 1/4" J34

U06010001

Assortment with hexagonal sockets and bits in modular box

DESCRIPTION	SIZE	PCS
Hexagonal sockets 1/4"	4-4,5-5-5,5-6-7-8-9-10-11-12-13-14	13
Reversible ratchet 1/4"		1
Spinner with handle 1/4"		1
Extensions 1/4"	55-100	2
Bits for slot-head screws 1/4"	4-5,5-6	3
Bits for PHILLIPS® screws 1/4" PH	1-2-3	3
Bits for hexagonal screws 1/4"	4-5-6	3
TORX® bits 1/4"	T10-T15-T20-T25-T30-T40	6
Universal joint 1/4"		1
Bit-holder socket 1/4-1/4"		1



22
PIECES

1/
2"



4 kg 375 mm 80 186

601 1/2" J22

U06010003

Assortment with hexagonal sockets in modular box

DESCRIPTION	SIZE	PCS
Hexagonal sockets 1/2"	8-10-11-12-13-14-15-16-17-18-19-21-22-24-27-30-32	17
Reversible ratchet 1/2"		1
Extensions 1/2"	130-250	2
Universal joint 1/2"		1
T-handle 1/2"		1

USAG QUALITY AT A *Just* PRICE



1/4"

1/2"

8 kg
mm
415
92
283

100
PIECES



601 1/4-1/2" J100

U06010011

Assortment with hexagonal sockets and bits in modular box

The boxes are modular with USAG roller cabinet drawers



1/4"

1/2"

7 kg
mm
415
92
283

82
PIECES



601 1/4-1/2" J82

U06010010

Assortment with hexagonal sockets and combination wrenches in modular box

The boxes are modular with USAG roller cabinet drawers



REVERSIBLE RATCHET 237 A WITH SEALED MECHANISM IP51.



Inversion system integrated into the cover



Head thickness reduced, compared to standard models



YouTube

CONICAL HANDLE in anti-slip bimaterial.

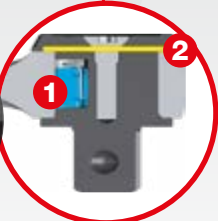

1. New patented pawl
2. Protective diaphragm

TOP PERFORMANCE

1. Static torsional resistance: +30% compared to the value required by ISO 3315 rules, with the patented pawl.
2. Effort resistance: assures twice the tightening cycles compared to standard products on the market, with IP51 protection.



$\frac{1}{4}$ "

237 $\frac{1}{4}$ " A

U02370102

Reversible ratchet with sealed mechanism (certified IP51)



$\frac{3}{8}$ "

237 $\frac{3}{8}$ " A

U02370104

Reversible ratchet with sealed mechanism (certified IP51)



$\frac{1}{2}$ "

237 $\frac{1}{2}$ " A

U02370106

Reversible ratchet with sealed mechanism (certified IP51)

REVERSIBLE RATCHET WITH REVOLVING HANDLE

$\frac{1}{4}$ "

237 $\frac{1}{4}$ " AK

U02370003

Reversible ratchet with revolving handle



$\frac{1}{2}$ "

237 $\frac{1}{2}$ " AK

U02370009

Reversible ratchet with revolving handle





23
PIECES

1/2"

3 kg
mm
↔ 330
↑ 60
↙ 215

606 1/2" EA
U06060302



Assortment with hexagonal sockets in ABS case

- High resistance ABS case with quick closing system

DESCRIPTION	ITEM/SIZE	PCS
Hexagonal sockets	235 1/2 EN 8-9-10-11-12-13-14-15-16-17-18-19-21-22-23-24-27-30-32	19
Extensions	236 1/2 125-250	2
Universal joint	241 1/2	1
Reversible ratchet with sealed mechanism (certified IP51)	237 A 1/2	1



19
PIECES

1/4"

1 kg
mm
↔ 210
↑ 60
↙ 130

606 1/4" EA
U06060101



Assortment with hexagonal sockets in ABS case

- High resistance ABS case with quick closing system

DESCRIPTION	ITEM/SIZE	PCS
Hexagonal sockets	235 1/4 EN 4-4,5-5-5,5-6-7-8-9-10-11-12-13-14	13
Extensions	236 1/4 50-100	2
Universal joint	241 1/4	1
T-handle with sliding square drive	240 1/4	1
Spinner with handle	243 1/4	1
Reversible ratchet with sealed mechanism (certified IP51)	237 A 1/4	1



17
PIECES

3/4"



612 3/4" EB
U06120017



13 kg
mm
↔ 425
↑ 83
↙ 395

Assortment in sheet steel box with hexagonal sockets

DESCRIPTION	ITEM/SIZE	PCS
Hexagonal sockets	235 3/4 N 22-23-24-26-27-28-30-32-36-38-41-46-50	13
Extensions	236 3/4 200-400	2
T-handle with sliding square drive	240 3/4 N	1
Reversible ratchet with sealed mechanism	237 B 3/4	1

612 3/4" B
U06120016



**BIHEXAGONAL
SOCKETS**

Assortment in sheet steel box with bihexagonal sockets

XGRIP



DISCOVER THE X-GRIP RANGE

Go to page 4

Ratchets and sockets



YouTube



MINI TIGHTENING RANGE

Compact dimension.
Top performance.

Socket-holder

31
PIECES

1/4"

180°

350 g mm → 120
↓ 30
↙ 60

606 1/4" SK U06060012

Assortment with bits and reversible ratchet

DESCRIPTION	ITEM/SIZE	PCS
Reversible ratchet	237 1/4" SFK	1
Bits for slot-head screws -1/4"	660 0,5x4-1x5,5	2
Bits for hex socket screws -1/4"	660 E 1,5-2-2,5-3-4-5-6-7-8	9
Bits for PHILLIPS® screws -1/4"	660 PH 1-2-3	3
Bits for POZIDRIV® - SUPADRIV® screws -1/4"	660 PZ 1-2-3	3
Socket-holder bit - 1/4"	660 Q 1/4"	1
Bits for TORX® Tamper Resistant screws -1/4"	660 STX T10-T15-T20-T25-T27-T30-T40	7
Bits for TORX® screws -1/4"	660 TX T6-T7-T8-T9	4
Magnetic bit-holder adapter - 1/4"	672 1/4" MG 100	1

610 1/4" EFK U06100001

Assortment with short hexagonal sockets and reversible ratchet in bimaterial box



YouTube

11 mm

11
PIECES

1/4"

265 g mm → 120
↓ 30
↙ 60

5,5-6-7-8-9-10-
11-12-13-14 mm

SHORT HEXAGONAL SOCKETS

They offer more accessibility also using a standard ratchet.



237 1/4" SK U02370062

Reversible ratchet with extension

- 180° swivel head
- Inversion system with integrated lever
- Ratchet mode: maximum accessibility with the compact head and adjustable hinge
- T-handle wrench mode: the extension (L 100 mm) becomes a crossbar and the ratchet can be used as a T-handle bit-holder



RANGE OF SOCKETS ADAPTERS



REDUCERS



NEW **3** PIECES

246 R/S3
U02460400

Set of 3 adapter

INCREASERS



NEW **4** PIECES

247 A/S4
U02470400

Set of 4 adapter

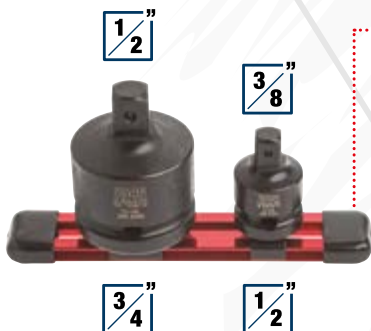

NEW **2** PIECES

246 RM/S2
U02460500

Set of 2 impact adapter

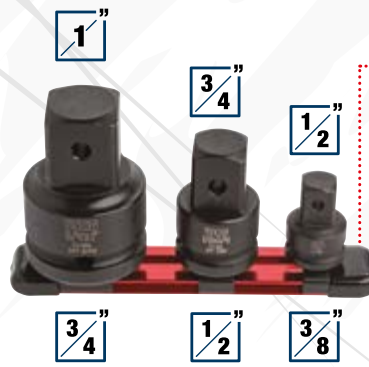

NEW **3** PIECES

247 AM/S3
U02470500

Set of 3 impact adapter

AS STRONG AS FEW. EASY FOR EVERYONE.

At the Gemonio (VA) plant, we designed and manufactured an innovative torque wrench that combines the extreme durability of our USAG ratchets with the ease of use of the direct torque reading system

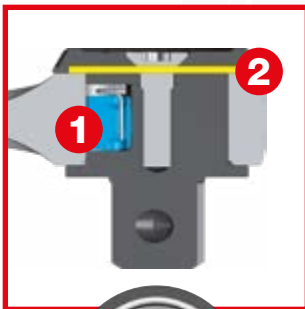

IP51 SEALED MECHANISM

1. High-strength pawl
2. Protective diaphragm



TOP PERFORMANCE

72-tooth mechanism with 5° ratcheting arc.
Reversal system integrated into the cover.
Increased durability guaranteed by the sealed mechanism.
Extreme resistance to static torsion.

DIRECT TORQUE READING

No longer necessary to learn how to combine the dual graduated scale with tens and units. This system makes torque adjustment simple and quick for everyone. You immediately see the set value, and **the numbers are 50% larger** than those on other wrenches on the market.

ADJUSTMENT RING

To set the torque, simply pull back the ring and rotate the handle. No additional locking system is needed: **the ring automatically returns to its position** and keeps the wrench set to the desired torque.

CLICK MECHANISM

The internal compression spring is designed to maintain accuracy even after many uses. The mechanism of the 810 SA is tested by USAG **to withstand up to 25,000 clicks**: 5 times what is required by ISO 6789 standards.



TORQUE WRENCHES 810 SA - 811 SA WITH DIRECT READ SYSTEM.

REVERSIBLE RATCHET
with 72 theet mechanism.

CLICK TORQUE SYSTEM
with compression spring.

NEW



YouTube

**SEALED MECHANISM. THE
TOP OF DURABILITY.**

ADJUSTMENT RING
with automatic return

CONICAL HANDLE
in anti-slip bimaterial.

IP 51

PROTECTION FROM
DUST AND WATER

810 SA

ISO 6789

Direct read torque wrench with reversible ratchet

- Calibration certificate and REACH (SVHC) declaration included

ITEM	CODE	CAPACITY	☑	L (mm)	RESOL.
810 SA 50	U08105102	10÷50 Nm	3/8"	350	0,25
810 SA 100	U08105103	20÷100 Nm	1/2"	410	0,5
810 SA 200	U08105105	40÷200 Nm	1/2"	475	1,0
810 SA 340	U08105106	60÷340 Nm	1/2"	630	1,0

NEW

ACCURACY
±4%

3/8"

1/2"

**CLOCKWISE
TIGHTENING**

811 SE

ISO 6789

Direct read torque wrench with removable ratchet

- Calibration certificate and REACH (SVHC) declaration included

ITEM	CODE	CAPACITY	☑	☐	L (mm)	RESOL.
811 SE 50	U08115012	10÷50 Nm	3/8"	9x12	370	0,25
811 SE 100B	U08115013	20÷100 Nm	3/8"	9x12	430	0,5
811 SE 100C	U08115015	20÷100 Nm	1/2"	9x12	430	0,5
811 SE 200	U08115017	40÷200 Nm	1/2"	14x18	510	1,0
811 SE 340	U08115018	60÷340 Nm	1/2"	14x18	665	1,0

NEW

ACCURACY
±4%

3/8"

1/2"

Removable
ratchet

**CLOCKWISE AND
COUNTERCLOCKWISE
TIGHTENING**

CLICK TORQUE BAR 811 LB PERFECT MATCH OF ACCURACY AND RESISTANCE

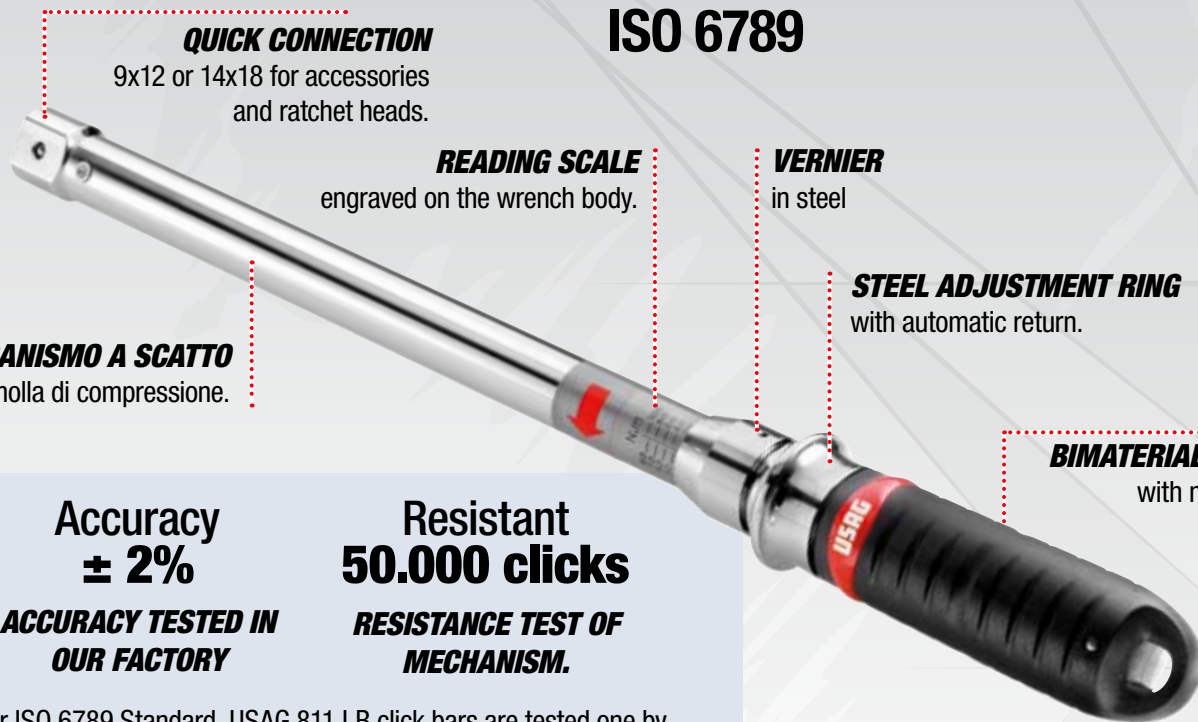

QUICK CONNECTION

9x12 or 14x18 for accessories and ratchet heads.

ISO 6789

READING SCALE

engraved on the wrench body.

VERNIER

in steel

STEEL ADJUSTMENT RING

with automatic return.

MECCANISMO A SCATTO
con molla di compressione.

BIMATERIAL HANDLE

with no-slip grip.

Accuracy
± 2%

**ACCURACY TESTED IN
OUR FACTORY**

Resistant
50.000 clicks

**RESISTANCE TEST OF
MECHANISM.**

As per ISO 6789 Standard, USAG 811 LB click bars are tested one by one in production, before being packaged. These bars can keep an accuracy between ±2% and ±4%, even after 5,000 tightenings.



YouTube



**CLOCKWISE AND
COUNTERCLOCKWISE
TIGHTENING**

ACCURACY
±2%

811 LB

Click torque bar

ITEM	CODE	CAPACITY	□	L	RESOL.
811 LB 50	U08115021	10÷50 Nm	9x12 mm	357 mm	1 Nm
811 LB 100	U08115023	20÷100 Nm	9x12 mm	437 mm	1 Nm
811 LB 200	U08115024	40÷200 Nm	14x18 mm	515 mm	1 Nm
811 LB 350	U08115025	70÷350 Nm	14x18 mm	725 mm	2 Nm

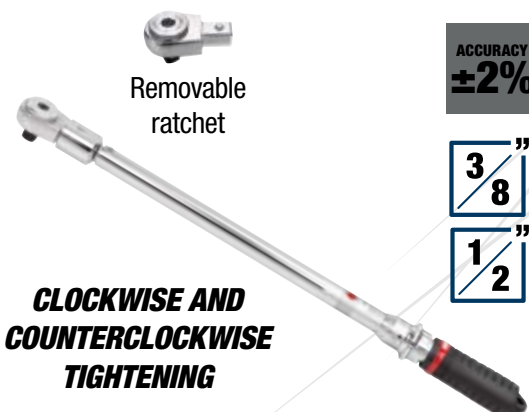

Removable
ratchet

ACCURACY
±2%

3/8"

1/2"

811 LBE

Click torque wrench with removable ratchet

ITEM	CODE	CAPACITY	□	□	L	RESOL.
811 LBE 50	U08115026	10÷50 Nm	3/8"	9x12 mm	407 mm	1 Nm
811 LBE 100B	U08115027	20÷100 Nm	3/8"	9x12 mm	487 mm	1 Nm
811 LBE 100C	U08115028	20÷100 Nm	1/2"	9x12 mm	487 mm	1 Nm
811 LBE 200	U08115029	40÷200 Nm	1/2"	14x18 mm	565 mm	1 Nm
811 LBE 350	U08115032	70÷350 Nm	1/2"	14x18 mm	775 mm	2 Nm

810 N

ISO 6789

Torque wrenches with reversible ratchet

- Sensible and audible alarm on reaching preset torque value
- Automatic resetting on pressure release after disengagement
- Supplied with test certificate

ITEM	CODE	CAPACITY	□	L	RESOL.
810 N 5	U08104000	1÷5 Nm	1/4"	197 mm	0,05
810 N 25	U08104001	5 ÷ 25 Nm	1/4"	290 mm	0,05

**CLOCKWISE
TIGHTENING**

ACCURACY
±4%

1/4"

**CLOCKWISE AND
COUNTERCLOCKWISE
TIGHTENING**

Removable
ratchet

ACCURACY
±4%

1/4"

811 NE

ISO 6789

Torque wrenches with removable reversible ratchet

- Adjustable torque model for use in combination with fittings from the 811-series
- Sensible and audible alarm on reaching preset torque value
- Automatic resetting on pressure release after disengagement
- Supplied with test certificate

ITEM	CODE	CAPACITY	□	○	L	RESOL.
811 NE 5	U08114009	1÷5 Nm	1/4"	9x12 mm	185 mm	0,05
811 NE 25	U08114010	5÷25 Nm	1/4"	9x12 mm	300 mm	0,05

812 N

ISO 6789

Torque wrenches with reversible ratchet

- Adjustable torque model for clockwise and counterclockwise tightening by turning the ratchet 180°
- Accuracy ± 4% of the preset torque value
- Readings in Nm
- Sensible and audible alarm on reaching preset torque value
- Automatic resetting on pressure release after disengagement
- Safety block after setting torque
- Supplied in sheet steel box with test certificate

ITEM	CODE	CAPACITY	□	○
812 N 600	U08120006	120 ÷ 600 Nm	3/4"	14x18 mm
812 N 1000	U08120010	200 ÷ 1000 Nm	3/4"	-

**CLOCKWISE AND
COUNTERCLOCKWISE
TIGHTENING**

ACCURACY
±4%

3/4"

824 A

ISO 6789

Torque screwdrivers

- Adjustable torque model for clockwise tightening, for use in combination with bits from the 660 series or, using an adapter, with sockets from the 1/4" manual series
- Accuracy ± 6% of the preset torque value
- Readings in Nm
- Automatic disengagement on reaching the preset torque value
- Automatic resetting after 120°
- Supplied with regulation key and test certificate

CODE	CAPACITY	L	RESOL.
U08240004	0,5÷2,5 Nm	145 mm	0,1
U08240006	2÷10 Nm	167 mm	0,5

1/4"

ACCURACY
±6%

SCISSORS 207 E STEEL STRENGTH.



YouTube



**THE ONLY ONE WITH INTEGRAL
STAINLESS STEEL STRUCTURE**

Flexural strength 180 Kg.

**BUILT-IN WIRE
STRIPPER**

**CABLE CUTTER ON
BOTH BLADES**

**MICRO ANTI-SLIP
TOOTHING**



1. Stripping
2. Crimping



Suitable for
multi-core cables.



207 E
U02070006



Professional scissors for electricians

SCISSORS 207 D THE REFERENCE FOR ELECTRICIANS.



**HANDLES RESISTANT
TO FLEXURAL
STRENGTH UP TO 80 KG**
glass-reinforced technopolymer.

50 mm²

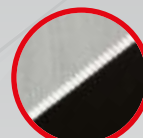

FLUID AND STRONG BLADES
with micro tothing and cable cutter.



**OVERSIZED
HOLES**

207 D
U02070008



Scissors for electricians,
stainless steel blades



YouTube

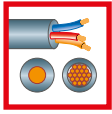

0,02÷10 mm²



146 A
U01460003

Automatic wire strippers, straight

- Cutting and stripping functions for electrical wires
- Capacity 0,02-10 mm²/AWG 34-80
- Interchangeable jaws without tools
- Built-in wire cutter
- Precise adjustment of the stripping diameter to avoid damages
- Adjustable stripping length
- After each stripping operation, the jaw opens automatically to facilitate the extraction of the wire
- Ergonomic bimaterial handles



15÷25
WATT

MAX
495°C

063 W
U00630002

Electronic pen-type soldering iron, double power

- Professional soldering iron for tin
- Push-button switch
- Perfect for different applications on electrotechnical field
- Steel tip for long service life
- Housing in plastic material resistant to oils and hydrocarbons
- Power supply 230V
- Supplied with bench holder



2011/65/UE
2012/19/EC



Ø 4÷28 mm²



163
U01630001

Multi-purpose cable sheath stripper

- For circular and longitudinal stripping of cables with external sheathing in PVC
- Trigger system (-30% effort): necessary pressure 75N
- Roller for regulating cutting depth
- Self rolling stripping blade
- Trigger stop when blade is out
- Safety blade stop
- Ergonomic plastic body
- Spare blade included
- Kit of spare blades code 872272



YouTube

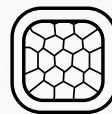

0,14÷10 mm²

753 KA
U07530004

Self-adjusting crimping pliers for square terminals

- For insulated and non-insulated terminals
- Capacity 0,14-10 mm²/AWG 26-8
- Opening system for multiple consecutive operations
- Allows to crimp applying little force on the handles
- Low weight and compact size for easy handling

Insulated



Not-Insulated



SMART FUNCTION

Automatically selects
AC/DC voltage,
resistance, frequency



MAX
600 V

RMS

074 A
U00740001

230 g 72
mm 152
 45

SMART digital multimeter

- AC/DC measurement
- Resistance and continuity measurements (acoustic sound if circuit resistance is lower than 40 to Ω)
- Frequency measurements
- AC/DC current measurement with 076 P ammeter



CAT III 600V

TECHNICAL CHARACTERISTICS

Direct voltage DC	1÷600 mV÷V
Alternating voltage AC	1÷600 mV÷V
Resistance	0÷10 Ω ÷M Ω
Frequency	3÷40 kHz
Battery type (supplied)	2xAAA 1,5V

NEW



MAX
600 V

TRUE
RMS

076 M
U00760007

224 g 80
mm 160
 35

Digital multimeter with TRUE RMS reading

- Detectable parameters: AC/DC voltage and current, resistance, continuity, diode test, capacitance, frequency, duty cycle, temperature, DWELL, engine speed, pulse width



CAT III 600V

TECHNICAL CHARACTERISTICS

V	6 ÷ 600V
V	600mV ÷ 600V
Ω	600 ÷ 60M
Hz	Frequency: 9,999 Hz ÷ 9,999 MHz
A	60mA ÷ 10A
A	60mA ÷ 10A
°C	-20°C ÷ 1.000°C
DWELL	90° (4 cil) ÷ 45° (8 cil)
RPM	60 ÷ 20.000 giri/min
	Overload protection 600 V

NEW



MAX
600 V

TRUE
RMS

076 MC
U00760008

264 g 70
mm 220
 44

Ammeter and digital multimeter TRUE RMS

- Detectable parameters: AC/DC voltage and current, resistance, continuity, diode test, temperature, capacitance, duty cycle, and frequency



CAT III 600V

TECHNICAL CHARACTERISTICS

V \sim	0÷600 V
V \equiv	0÷600 V
Ω	0 ÷ 60M
	SI
	SI
Hz	Frequency : 1 Hz÷9,99 MHz
A \sim	0÷600 A
A \equiv	0÷600 A
%	5%÷95%

360°



ALUMINIUM

995 AF
U09950006

Hand riveter with swivel head

- 360° adjustable head
- Suitable for Aluminum rivets
- 4 interchangeable heads
- Light alloy body
- Plastic handles
- Metal clip for opening lock
- Supplied with head disassembly key



ALUMINIUM
AND STEEL

995 A
U09950001

Hand riveter

- Steel: Ø 2,4 - 3,2 - 4 (3/32 - 1/8 - 5/32)
- Aluminium: Ø 2,4 - 3,2 - 4 - 4,8 mm (3/32 - 1/8 - 5/32 - 3,16")
- Light alloy body
- Pressed sheet steel pressure lever
- Handgrips with spring-action opening
- Supplied with three interchangeable nozzles and service key



**-20%
EFFORT**

COMPACT AND POWERFUL

Only 330 mm long
20% less effort than the standard model



ALUMINIUM
AND STEEL

995 LA
U09950004

Straight compact hand riveter

- Compact model with the same capacity as a standard long riveter
- The internal lever system reduces operator effort
- Suitable for Aluminum and steel rivets
- 5 interchangeable heads
- Removable holder for spent nails
- Light alloy body
- Plastic handles

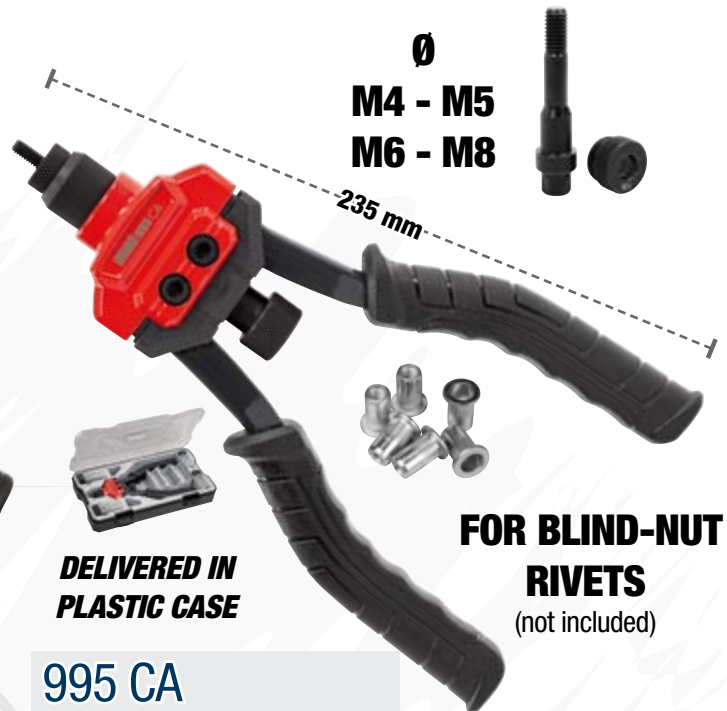

Ø
M4 - M5
M6 - M8

**DELIVERED IN
PLASTIC CASE**

**FOR BLIND-NUT
RIVETS**
(not included)

995 CA
U09950008

Hand riveter for blind-nut rivets

- Compact model with internal lever system that reduces operator effort
- Supplied with 4 interchangeable heads (M4-M5-M6-M8)
- To be used with aluminium and steel blind nuts (M4-M5-M6-M8) and stainless steel (M4-M5)
- Light alloy body
- Plastic handles
- Supplied in a plastic case (LxDxH: 320x175x50 mm) with blind nuts holders (not included)

**STAINLESS
STEEL BLADE**

211 A
U02110001

Multi-purpose scissors

- Blade with micro anti-slip toothing
- Selection lever to adapt to small and big hands
- Security lever to block the blades
- Antislip bimaterial ergonomic handgrips

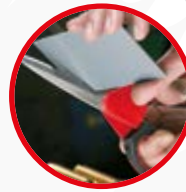

210 C
U02100003

Multi-purpose scissors

- Stainless steel blade with micro antislip toothing
- Big ergonomic bimaterial handless
- Perfect for Aluminium, cardboard, rubber, leather, moquette, etc.

**STAINLESS
STEEL BLADE**



**FOR
RIGHT-HANDERS**



200 S
U02000002

Hacksaw

- Steel body with anti-slip and shock resistant plastic coating
- Supplied with Cobalt blade 200 C24

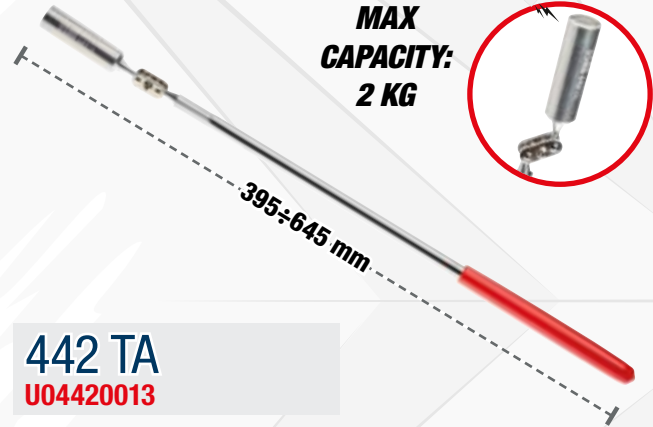

**MAX
CAPACITY:
2 KG**

442 TA
U04420013

Telescopic retriever with articulated magnet

- For recovering magnetizable items from inaccessible places
- Articulated head: aluminum
- Shaft material: carbon steel with zinc finishing
- PVC handle

**CENTRAL
CUTTER**

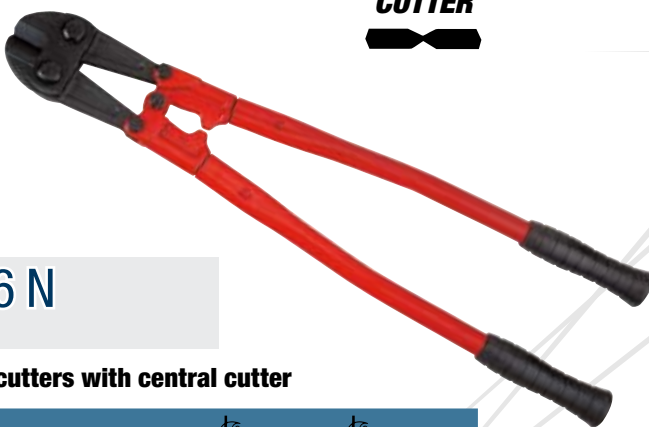

196 N

Bolt cutters with central cutter

CODE	LENGTH	2000 N/mm ² Ø MAX	1600 N/mm ² Ø MAX	
U01960002	450 mm	6 mm	7 mm	1,9 Kg
U01960003	600 mm	7 mm	10 mm	3,5 Kg
U01960004	750 mm	9 mm	13 mm	4,5 Kg
U01960005	900 mm	10 mm	16 mm	6,1 Kg
U01960006	1050 mm	11 mm	18 mm	8,3 Kg

**SEMI-FLUSH
CUTTER**

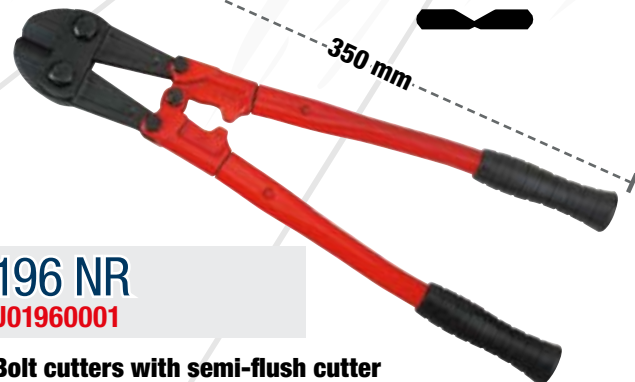

196 NR
U01960001

Bolt cutters with semi-flush cutter

- Blades with high-resistance cutting edges
- Handgrips in PVC

DIN 338

HSS-G

14
PIECES



988 LA/S14

U09880070

Assortment with tap and drills

- Ø drills: 2,5-3,3-4,2-5,0-6,8-8,5-10,2
- M taps: 3x0,5-4x0,7-5x0,8-6x1-8x1,25-10x1,5-12x1,75

DIN 338

HSS-G

19
PIECES



988 MA/S19

U09880073

Assortment with drills

- Ø drills: 1,0-1,5-2,0-2,5-3,0-3,5-4,0-4,5-5,0-5,5-6,0-6,5-7,0-7,5-8,0-8,5-9,0-9,5-10,0

DIN 338

HSS-G

25
PIECES



988 MA/S25

U09880074

Assortment with drills

- Ø drills: 1,0-1,5-2,0-2,5-3,0-3,5-4,0-4,5-5,0-5,5-6,0-6,5-7,0-7,5-8,0-8,5-9,0-9,5-10,0-10,5-11,0-11,5-12,0-12,5-13,0



HSS

3
PIECES



988 D/S3

U09880020

Set in sheet steel case

ITEM	Ø STEPS	Ø SHAFT	LENGTH
988 D1	4-5-6-7-8-9-10-11-12 mm	6 mm	65 mm
988 D2	4-6-8-10-12-14-16-18-20 mm	8 mm	75 mm
988 D3	4-6-8-10-12-14-16-18-20-22-24-26-28-30 mm	10 mm	100 mm

HSS

12
PIECES



988 G/S12

U09880100

Set of 10 bimetallic hole saws

- 10 pcs 988 G (Ø 19-22-25-29-35-38-44-51-57-64)
- Cutting depth Max 38 mm

HSS

10
PIECES



Ø 6 mm



988 E/S10

U09880062

Set of ten rotary burrs in hard metal

- 8 pcs. (Ø 10 and 12 shapes EA-EC-EF-EG)
- 2 pcs (Ø 12 shapes ED-EM)



454

Outside pullers with two jaws

CODE	A	B	POWER	Hex
U04540000	65 mm	70 mm	1,5 t	13 mm
U04540010	90 mm	110 mm	3 t	17 mm
U04540020	130 mm	110 mm	3 t	17 mm
U04540030	175 mm	165 mm	4 t	17 mm
U04540040	220 mm	165 mm	4 t	17 mm
U04540050	270 mm	220 mm	5 t	21 mm
U04540060	340 mm	220 mm	5 t	21 mm

INCLUDED IN THE PRICE



4
PIECES

451 N/S4

U04510100

Outside puller with three jaws

- Model with self-locking jaws
- Safety pin
- Working screw with 18 mm hexagonal drive
- Possibility of using with two jaws
- Carbon steel pressure screw
- Chrome Vanadium steel body
- Chrome plated and burnished finish
- Working screw M16x2
- Spare safety pins: U.306- 24J3

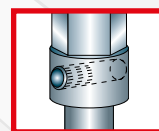

Safety pin increases working safety and preserves tool quality

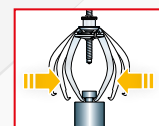

Self-locking self-centring

2-3-4-5-6-8 mm



New pouch

367 SE6

U03670081

6
PIECES

Set of 6 pin punches

- 367/2x115-3x125-4x145-5x165-6x180-8x200 mm
- Supplied in a compact fabric pouch
- Chrome Vanadium steel
- Inserted phosphatised tips for the 2 and 3 mm sizes

PIN PUNCH WITH HANDLE

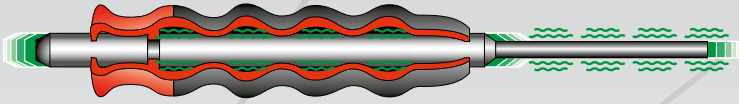

Ergonomic handle with shock absorption system.
More stable and secure grip.

NEW



2-3-4-5-6-8 mm

367 A SE6
U03670115

6
PIECES

Set of 6 pin punches with handle

- 367/2x140-3x150-4x195-5x205-6x210-8x220 mm.
- Supplied in a high-strength fabric pouch.
- Chrome vanadium steel.
- Tipped and phosphated points for sizes 2 and 3 mm.

DRIFT RANGE

NEW



373

Standard drift

- Steel body
- Interchangeable nylon pads with Shore hardness D74

CODE	L	Ø	🏋️
U03730166	166 mm	10 mm	100 g
U03730175	175 mm	15 mm	200 g

Ø 20 mm

NEW



373 A
U03730120

🏋️
220 g

Non-rebound drift

- Steel body
- Contains steel balls that eliminate the rebound following the strike
- Interchangeable nylon tips with shore hardness D74



DEAD BLOW MALLET

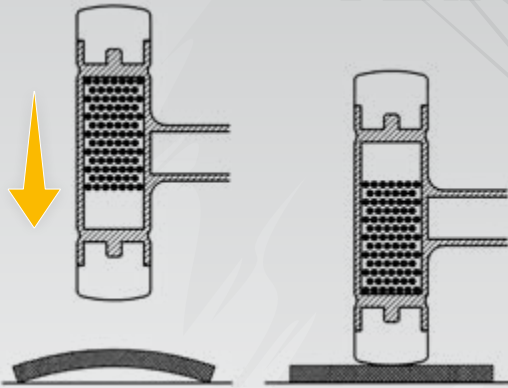

In dead blow mallets, the head is partially filled with steel balls. With each strike, they allow for rebound absorption and provide perfect balance.



STEEL BODY
with interchangeable plastic inserts.



MONOBLOCK
The head and handle are a single unit.

374 N

Non-rebound mallets

- Model with interchangeable plastic tips
- Head partially filled with metal pellets to absorb rebound
- Carbon steel body

CODE	Ø TIP	LENGTH
U03740004	35 mm	310 mm
U03740005	40 mm	315 mm
U03740006	50 mm	325 mm
U03740007	60 mm	335 mm

374 G

Non-rebound mallet monoblock

- Dead blow hammer with steel microbeads
- Steel body and handle overmolded with polyurethane
- Striking surface with Shore hardness D45 ± 5
- Ergonomic PVC handle

CODE	Ø TIP	LENGTH
U03740040	40 mm	298 mm
U03740050	50 mm	308 mm
U03740060	60 mm	316 mm



STEEL BODY
with interchangeable
plastic inserts.

376

UNI 7784

Mallets

- Model with interchangeable plastic tips
- Carbon steel body
- Ash wood handle

CODE	Ø TIP	LENGTH
U03760001	22 mm	250 mm
U03760002	28 mm	275 mm
U03760003	35 mm	300 mm
U03760004	42 mm	325 mm
U03760005	50 mm	350 mm
U03760006	60 mm	380 mm



Head in Carbon steel forged and subjected to differentiated heat treatment to guarantee a longer life and avoid chipping or upsetting of the striking surface.

Handle protection below the head

382

UNI 7777 DIN 6475

Hammers for mechanics

- German model with flat square head and symmetric peen
- Ash wood handle

CODE	HEAD	LENGTH
U03820002	100 g	260 mm
U03820004	200 g	280 mm
U03820006	300 g	300 mm
U03820007	400 g	310 mm
U03820008	500 g	320 mm
U03820009	600 g	330 mm
U03820010	800 g	350 mm
U03820011	1000 g	360 mm
U03820013	1500 g	380 mm
U03820014	2000 g	400 mm



COMBINED MATERIALS FOR EXCELLENT RESULTS

- 1 Graphite core: maximum flexural strength.
- 2 High quality: Polypropylene body to absorb vibrations.
- 3 Rubber coating resistant to hydrocarbons.

382 F

DIN 1041

Hammers for mechanics with graphite handle

- German model with flat square surface and symmetric peen
- Graphite handle

CODE	HEAD	LENGTH
U03820102	200 g	285 mm
U03820103	300 g	300 mm
U03820105	500 g	310 mm
U03820107	800 g	350 mm
U03820108	1000 g	355 mm

Lighting



YouTube



Adjustable hooks



SMD LED



COB LED



1 = 18 h
2 = 3,6 h
3 = 1,8 h



Li-ion

RECHARGEABLE



USB-C

889 RL

U08890036

LED inspection lamp

DUAL USE



45 LUMEN

LAMP



MAX 420 LUMEN

TORCH

2 brightness levels (120 and 420 lumen)



YouTube



Magnetic base and hook clamp



SMD LED



COB LED



1 = 3 h
2 = 10 h
3 = 35 h



Li-ion

RECHARGEABLE



USB-C

889 IL

U08890046

Articulated LED inspection lamp

TRIPLE FUNCTION



50 LUMEN

HEAD



400 LUMEN

TORCH



150 LUMEN

FRONTAL



YouTube



MOTION DETECTION SENSOR



SMD LED



IP54



1 = 18 h
2 = 3,6 h
3 = 1,8 h



Li-ion

RECHARGEABLE



USB-C

889 GR

U08890044

LED compact spotlight

3 BRIGHTNESS LEVELS



MAX 500 LUMEN

50, 250 and 500 lumen with a simple touch

Only 94 mm length



COB LED



IP20



1 = 1,5 h
2 = 3 h
3 = 3h



Li-ion

889 SP

U08890055

LED pocket pen lamp



YouTube

RECHARGEABLE



USB-C

DUAL USE



Frontal



Torch

Magnetic hook that can be rotated 360°

Aluminium body



Lamp
COB LED



Torch
SMD LED



IP20



Li-ion

889 RP

U08890045

Compact LED rechargeable inspection lamp



YouTube

RECHARGEABLE



USB-A

DUAL USE



Lamp



Torch

360°

131 mm

180°



COB
LED



Torch
SMD LED



4 h



Lampada
1 = 10 h
2 = 5 h



Torcia
1 = 9 h
2 = 5 h



Li-ion

889 CM

U08890048

Flexible LED inspection lamp



YouTube

RECHARGEABLE



USB-C

DUAL USE



Lamp



Torch

550 mm

FLEXIBLE

NEW

INTEGRATED TRANSFORMER

No external power supply.



YouTube

12 V **1200 A**

↔ 400
↑ 320
↓ 115
10 kg mm



1613 RA12

U16130019

Professional start booster 12 V, portable

- Shockproof ABS shell
- Also suitable for sealed batteries

3500 A

Cable length
155 cm

REAR CONNECTOR FOR VOLTAGE SELECTION



12 V **1400 A**
24 V **700 A**

↔ 560
↑ 590
↓ 200
20,8 kg mm



12V - 3700 A

24V - 1860 A

1613 AGM12-24

U16130013

Professional start booster 12-24 V, portable

- Shockproof ABS shell
- Overvoltage protection

Cable length
155 cm



YouTube

COMPRESSION POWER

735 kg (6 bar), 1226 kg (10 bar).

447 T

U04470101

Universal pneumatic shock absorber dismantler

- Ideal for cars
- Supplied with lower brackets 447 TC1 (78÷130 mm) and 447 TC2 (105÷182 mm), vice 447 TA and universal upper clamps 447 TB1

TECHNICAL CHARACTERISTICS

Compression power	735 kg (6 bar) - 1226 kg (10 bar)
Recommended air pressure	6÷10 bar
Piston stroke	420 mm
Cylinder	Aluminium alloy and nylon resin

↔ 470
↑ 1.390
↓ 450
60 kg mm



Adjustable pressure up to 4 BAR

12 V

10
Liters

2847/3

U28470084

Brake bleeder

- For changing, filling and bleeding the circuit of brakes on cars and industrial vehicles
- Device designed exclusively for brake fluids DOT 3, DOT 4, DOT 5.1. No LHM.

TECHNICAL CHARACTERISTICS

Operating liquid system	Peristaltic pump (no direct/liquid contact, no air pressure on liquid)
Power supply	12 V (alligators clips)
Tank capacity	10 liters
Pressure limiting device	4 bar
Elastic spiral hose	4 m (elastic)
Power cable	4 m



Supplied with:

- spare gaskets
- 1 multi-diameter cap 44-45-46 mm (2847 N11)
- 1 tank for oil recovery.

890 N
U08900002

210 g 82 mm 131 mm 21 mm

Battery tester 12V

- Allows testing of the battery health, starting system, and charging system
- Usable with 12V batteries, with capacity 100-2000 CCA, BCI, CA, MCA, IT, SAE; 100-1400 DIN, IEC; JIS 26A17-245H2
- Enables testing of standard (Lead-acid), GEL, EFB, Flat AGM, Spiral AGM, Lithium batteries
- Backlit screen
- Cable length (including clamps): 94 cm
- Reverse polarity protection
- 8 selectable languages: Italian, English, German, French, Dutch, Russian, Spanish, and Portuguese
- Battery can be tested both onboard and off the vehicle
- The tester provides 99.5% accurate results

NEW



**BATTERY TEST
CHARGING TEST
STARTING TEST**

**Cable length
94 cm**



**IDEAL TO DROP OIL INTO
THE CAR DIFFERENTIAL**

**Not suitable for fuels and
mineral oils**

**1,5
Liters**



**IDEAL FOR SUCTION AND DISPENSING OF
OIL, ANTIFREEZE, POWER STEERING OIL**



421 M
U04210021

Suction gun

421 P
U04210020

Suction gun

**3
Liters**

**IDEAL TO DROP OIL INTO THE
CAR DIFFERENTIAL**

Working
pressure
6÷10 bar



2847 A
U28470086

Vacuum brake bleeder



**9,5
Liters**



4,1 kg 230 mm 627 mm 302 mm

1785 B
U17850005

Fluid extractor





30,5 kg
mm
↔ 615
↙ 344

32,5 kg
mm
↔ 762
↙ 350

2550 A
U25500001

3
TON
30,5
kg



3t



2550 B
U25500002

2
TON
32,5
kg



2t



Hydraulic service jack 3t for cars and commercial vehicles

- Steel structure
- High capacity for use on cars, SUVs and vans
- Dual pump system to lift the car faster
- Equipped with manual descent control
- Air bleed valve, to avoid risk of over-load

Hydraulic service jack 2t

- Steel structure
- Versatile and compact for use in narrow spaces
- Dual pump system to lift the car faster
- Equipped with lifting pedal
- Equipped with manual descent control
- Air bleed valve, to avoid risk of over-load

2
PIECES

1950 C

Pair of jack stands

- Adjustable height with toothed mechanism and lever release
- Locking pin with chain
- 1950 C/3: model adjustable in 10 positions
- 1950 C/6: model adjustable in 13 positions



4,6 kg
mm
↔ 1.030
↑ 480
↙ 115

2000 A
U20000100

Inspection creeper

- Headrest in vinyl resistant to hydrocarbons, padded with high resistance foam rubber
- Plastic body resistant to hydrocarbons, washable



CODE	CAPACITY	H MAX	H MIN	DIMENSIONS	📦
U19501001	3 t	427 mm	300 mm	207x188 mm	7 kg
U19501002	6 t	620 mm	400 mm	285x250 mm	14 kg

YouTube
**VIDEO
TUTORIAL**



**10
PIECES**

WHEEL LOCKING NUTS AND SCREWS REMOVER KIT

272 DS
U02720001



Kit to extract nuts and screws from alloy wheels

- Does not damage the alloy rim
- Special tungsten carbide drills capable of drilling any type of material (lubricate with cutting oil at each use)
- Super thin conical sockets to center/extract on any type of alloy wheel

REINFORCED IMPACT SOCKETS 270



DIE-CAST STEEL RING

Ensures a resistance 4 times higher than standard wheel nut sockets.



PROTECTIVE TEFLON COATING

Reduces the risk of damage when working on aluminum alloy wheels.

NEW



1 1/2"



**3
PIECES**

1 1/2"

270

Reinforced impact socket wrenches for alloy wheels with Teflon protection

CODE	●	L	Ø
U02701017	17 mm	85 mm	26 mm
U02701019	19 mm	85 mm	28 mm
U02701021	21 mm	85 mm	30 mm

NEW

270 C3
U02700160

900 g mm 190
158
144

Assortment in modular case with impact sockets for alloy wheels with Teflon protection

FAST OIL-FILTER WRENCH 443 N AUTOMATIC BELT CLAMPING.

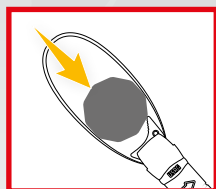

**AUTOMATIC
BELT CLAMPING**

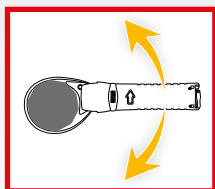

RATCHET EFFECT

Working rapidly. Possibility to work in narrow spaces.



**LEVER TO INCREASE
CLAMPING POWER**



**66÷105
mm**

443 N

U04430005

**Fast oil-filter wrench
(cars)**



YouTube

446 DA/SE6

U04461104

Set of 6 cup wrenches for oil filters

- 3/8" square drive
- Steel body
- Set for Fiat, Lancia, Alfa Romeo, BMW, Renault, Volkswagen, Skoda, Audi, Seat, Mercedes
- Profile dimensions: Ø 74 mm x 14 sides - Ø 75 mm x 16 sides - Ø 86 mm x 16 sides - Ø 102 mm x 14 sides - Ø 66 mm x 18 sides - Ø 96 mm x 18 sides

**6
PIECES**

3/8"

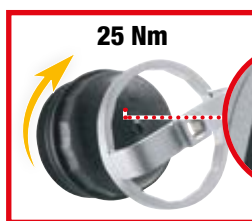

Allows the re-tightening at the original torque (value indicated on the plastic cap)



Frame the QR code and download the list of applications or go to usag-tools.net

3/8"

1/2"

**30
PIECES**

446 S28

U04461204

Set of 30 oil-filter cap wrenches

- Sizes of the oil-filter cap wrenches (Ø x N ° sides):
66/6 - 65/14 - 65/67 - 68/14 - 73/14 - 74/15 - 74/76 - 75/77 - 76/12 - 76/14 - 76/30 - 76/8 - 78/15 - 80/15 - 80/82 - 86/16 - 86/18 - 90/15 - 92/10 - 93/15 - 93/36 - 93/45 - 95/15 - 96/18 - 100/15 - 106/15 - 108/15 - 108/18.

7 kg 620 mm 70 mm 500 mm



Frame the QR code and download the list of applications or go to usag-tools.net



IN ALUMINIUM

446 DT/S2

U04461203

Set of two cap wrenches for oil filter covers - Japanese cars

- Reduces the risk of damage to the oil filter covers
- Can also be used for tightening with a torque wrench



2
PIECES

Connection for oil collector

16
PIECES

3/8"

263/S16

U02631400

Oil draining kit

- Magnetic sockets to hold plugs
- 1 hinged wrench 3/8"
- 2 bits \circ 8-10 mm 3/8"
- 6 bits \circ 8-10-12-13-14-17 mm 3/8"
- 6 hexagonal sockets \bullet 13-14-17-18-19-21 mm 3/8"
- 1 TORX® bit \circ T45



Integrated oil collection tray

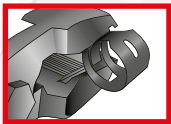

2 in 1



871 D

U08710001



Pliers for CORBIN clamps

- Model with frontal or side hooking
- Jaws with serrated gripping surface



870 C

U08700006

Pliers for fuel hoses

- For petrol and diesel vehicles
- Ergonomic bimaterial handgrip

3 working positions



871 C

U08719005P

CLICK spring-clips pliers

- Three-axial heads to work in any position
- To open and close CLICK spring-clips on fuel circuits, intake manifolds and hydraulic circuits



22
PIECES



1881 S22

U18810082

Set of 22 wrenches for assembling and disassembling the nuts of alternators pulleys

- Supplied in a plastic case



2 MODES:

- 1 250 l/min - 50°÷400°C
- 2 500 l/min - 50°÷600°C

MAX
600
GRADI

2000
WATT

391
U03910001

Digital heat gun

- Model with electronic checking of temperature and air volume by digital display
- Possibility to set programs: 2 heating modes and 2 air flows selectable
- Equipped with a cooling system

Accessories included



TECHNICAL CHARACTERISTICS

Suction cup threaded connection	M18
Sound level	78 Db
Total length	610 mm
Weight	4 Kg
Recommended air pressure	6,2 bar
Air inlet	1/4"

400 P
U04000010

Pneumatic dent puller

- Ideal to remove dents without the need to repaint
- Supplied with 3 suction cups (Ø 75-100-125 mm), in a plastic case with transport handle and closure clip
- Spare part kit with 3 suction cups: code 1004735-98

5
PIECES

To extract mouldings, fasteners, trim clips from door panels and dashboards



426 B/S5
U04260006

Set of 5 tools for plastic elements

4
PIECES

For removal of counterweights, silicone, mouldings etc.



426 C/S4
U04260007

Set of 4 multi-purpose plastic scrapers

4
PIECES

To separate timing belt cover, cylinder head engine, drive belt etc.



426 D/S4
U04260005

Set of 4 plastic separator scrapers

2
PIECES

115 CL/SE2
U01150022

Double-joint pliers with half-round jaws

- Ideal for gripping pieces and parts difficult to reach



Controlled tightening using ratchets or T-wrenches

1/2"



YouTube

814 A

Torque-angle digital adapter

- Torque and angle tightening with digital precision using conventional tools
- For CW and CCW tightening
- Measuring mode: peak/track
- Measuring unit: Nm/ft.lb/in.lb/kgcm/degree
- Visible (LED) and audible (BUZZER) indicators when preset target value is reached
- 9 presettable target values
- 50 memory slots for measured values
- Supplied in ABS case with calibration certificates
- Power supply: 2 batteries AAA (included)

CODE	CAPACITY	RESOL.
U08140003	6,8÷135 Nm	1/2" 0,1
U08140004	10÷200 Nm	1/2" 0,1
U08140005	17÷340 Nm	1/2" 0,1

Correct measurement of the angle in any position

ACCURACY
±2%



YouTube

831 A

U08310001

Digital angle meter

- Correct measurement of the angle in any position
- For CW and CCW tightening
- Accuracy: ± 2%
- Range: 0 - 360°
- Resolution: 0,1°
- Visible (LED) and audible (buzzer) indicators when preset target value is reached
- 9 presettable target values
- 50 memory slots for measured values
- Supplied in ABS case with calibration certificates
- Power supply: 2 batteries AAA (included)

9
PIECES

Two wire brushes
Ø 20mm and 25mm



885 F

U08850004

Injector cleaning kit

- Ideal for duct cleaning of injectors mounted on common rail engines

6
PIECES

1/2"



884 C/S6

U08841000

Set of six wrenches for injector pipes fittings

- For assembly and disassembly of injector pipes fittings
- Length: 98 mm
- Sizes: 12-14-16-17-18-19 mm

LED LIGHTING

1/2"

1.898 Nm 2,2 kg



YouTube

MAGNESIUM ALLOY CASING



THE TOP OF THE RANGE

943 PC1 1/2"

U09430001

Magnesium impact wrench with LED - the top

TECHNICAL CHARACTERISTICS

Square drive	1/2"	Recommended air pressure	6,2 bar
Bolt capacity	M20	Sound level	94 ±3 dB(A)
Max torque	1.898 Nm	Sound power	105 ±3 dB(A)
Torque in use (Nm min-Max)	320÷460 Nm	Vibrations	6,4 m/s ²
Strokes per minute	1200	Air inlet	1/4"
Free speed	6.500 giri/min	Ø internal hose	10 mm
Average air consumption	172 l/min	Weight	2,2 kg

MAGNESIUM ALLOY CASING

1/2"

1.600 Nm 2 kg



YouTube



THE REFERENCE MODEL

929 PC1 1/2"

U09290001

Magnesium impact wrench

TECHNICAL CHARACTERISTICS

Square drive	1/2"	Recommended air pressure	6,2 bar
Bolt capacity	M16	Sound level	93 ±3 dB(A)
Max torque	1.600 Nm	Sound power	104 ±3 dB(A)
Torque in use (Nm min-Max)	280÷440 Nm	Vibrations	6,2 m/s ²
Strokes per minute	1.300	Air inlet	1/4"
Free speed	7.000 giri/min	Ø internal hose	10 mm
Average air consumption	172 l/min	Weight	2,0 kg

EXTRA-COMPACT



942 PC3 1/2"

U09420012

Extra-compact impact wrench

TECHNICAL CHARACTERISTICS

Square drive	1/2"	Recommended air pressure	6,2 bar
Bolt capacity	M16	Sound level	91,1±3 dB(A)
Max torque	861 Nm	Sound power	108,1±3 dB(A)
Torque in use (Nm min-Max)	150÷220 Nm	Vibrations	9,57 m/s ²
Strokes per minute	1650	Air inlet	1/4"
Free speed	10.000 giri/min	Ø internal hose	10 mm
Average air consumption	127 l/min	Weight	1,3 kg

861 Nm 1,3 kg



YouTube

YouTube



Modular with the drawers of USAG roller cabinets

943 PC1/C12 U09430005

↔ 415
↓ 92
mm ↗ 283

1/2"

Assortment with hexagonal sockets and impact wrench in modular box

12
PIECES

DESCRIPTION	ITEM/SIZE	PCS
Magnesium impact wrench with LED - the top	943 PC1 1/2	1
Impact hexagonal sockets	235 1/2 M/ 10-13-17-18-19-22-24-27-30-32 mm	10
Lock pins	235 MCA/4-6	2
Safety rings	235 MDA/4-6	2
Impact extensions	236 1/2 M/125	1



Modular with the drawers of USAG roller cabinets

929 PC1/C12 U09290006

↔ 415
↓ 92
mm ↗ 283

1/2"

Assortment with hexagonal sockets and impact wrench in modular box

12
PIECES

DESCRIPTION	ITEM/SIZE	PCS
Magnesium impact wrench	929 PC1 1/2	1
Impact hexagonal sockets	235 1/2 M/ 10-13-17-18-19-22-24-27-30-32 mm	10
Lock pins	235 MCA/4-6	2
Safety rings	235 MDA/4-6	2
Impact extensions	236 1/2 M/125	1



Modular with the drawers of USAG roller cabinets

942 PC3/C7 U09420015

↔ 375
↓ 80
mm ↗ 186

1/2"

Assortment with hexagonal sockets and impact wrench in modular box

7
PIECES

DESCRIPTION	ITEM/SIZE	PCS
Extra-compact impact wrench	942 PC3 1/2	1
Impact hexagonal sockets	235 1/2 M/ 13-17-19-21-22-24 mm	6
Lock pins	235 MCA/4	1
Safety rings	235 MDA/4	1



LED LIGHTING

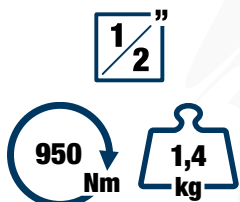

MAGNESIUM ALLOY CASING



943 PC2 1/2"
U09430002

Magnesium impact wrench with LED - extra compact

TECHNICAL CHARACTERISTICS

Square drive	1/2"	Recommended air pressure	6,2 bar
Bolt capacity	M16	Sound level	95±3 dB(A)
Max torque	950 Nm	Sound power	107±3 dB(A)
Torque in use (Nm min-Max)	200÷270 Nm	Vibrations	3,9 m/s ²
Strokes per minute	1400	Air inlet	1/4"
Free speed	10.000 giri/min	Ø internal hose	10 mm
Average air consumption	167 l/min	Weight	1,4 kg

ALUMINIUM BODY

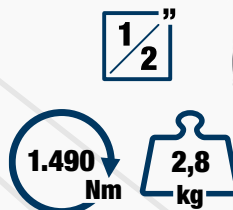

928 AC1 1/2"
U09280014

Aluminium impact wrench

TECHNICAL CHARACTERISTICS

Square drive	1/2"	Sound level	90 ±3 dB(A)
Bolt capacity	M16	Sound power	101 ±3 dB(A)
Max torque	1.490 Nm	Vibrations	5,2 m/s ²
Torque in use (Nm min-Max)	135÷380 Nm	Air inlet	1/4"
Strokes per minute	1.120	Ø internal hose	10 mm
Free speed	6.500 giri/min	Weight	2,8 kg
Average air consumption	147 l/min		
Recommended air pressure	6,2 bar		

TITANIUM ALLOY CASING

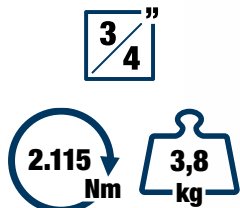

942 PD1 3/4"
U09420004

Impact wrench (Titanium structure)

TECHNICAL CHARACTERISTICS

Square drive	3/4"	Recommended air pressure	6,2 bar
Bolt capacity	M27	Sound level	97,8±3 dB(A)
Max torque	2.115 Nm	Sound power	108,8±3 dB(A)
Torque in use (Nm min-Max)	500÷800 Nm	Vibrations	5,06 m/s ²
Strokes per minute	950	Air inlet	3/8"
Free speed	5.300 giri/min	Ø internal hose	10 mm
Average air consumption	200 l/min	Weight	3,8 kg

ALUMINIUM BODY

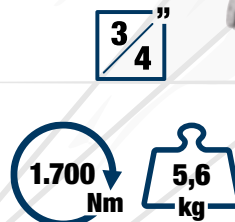

928 D1 3/4"
U09280015

Aluminium impact wrench

TECHNICAL CHARACTERISTICS

Square drive	3/4"	Recommended air pressure	6,2 bar
Bolt capacity	M24	Sound level	98,4±3 dB(A)
Max torque	1.700 Nm	Sound power	109,4±3 dB(A)
Torque in use (Nm min-Max)	500÷1.050 Nm	Vibrations	9,1 m/s ²
Strokes per minute	790	Air inlet	3/8"
Free speed	5.700 giri/min	Ø internal hose	13 mm
Average air consumption	193 l/min	Weight	5,6 kg

1"
1

4.068
Nm

10,3
kg



ALUMINIUM BODY

910 E1 1"
U09100020

Aluminium impact wrench

TECHNICAL CHARACTERISTICS

Square drive	1"	Recommended air pressure	6,2 bar
Bolt capacity	M33	Sound level	102 ±3 dB(A)
Max torque	4.068 Nm	Sound power	113 ±3 dB(A)
Torque in use (Nm min-Max)	850÷1.300 Nm	Vibrations	15,2 m/s ²
Strokes per minute	720	Air inlet	1/2"
Free speed	4.500 giri/min	Ø internal hose	13 mm
Average air consumption	243 l/min	Weight	10,3 kg

1"
1

3.390
Nm

6,8
kg



COMPOSITE MATERIAL FRAME

LIGHT AND POWERFUL

weighs a 20% less than a standard model

942 PE1 1"
U09420005

Impact wrench (composite material frame)

TECHNICAL CHARACTERISTICS

Square drive	1"	Recommended air pressure	6,2 bar
Bolt capacity	M38	Sound level	100,9 ±3 dB(A)
Max torque	3.390 Nm	Sound power	111,9 ±3 dB(A)
Torque in use (Nm min-Max)	203÷1.627 Nm	Vibrations	10,6 m/s ²
Strokes per minute	900	Air inlet	1/2"
Free speed	5.000 giri/min	Ø internal hose	19 mm
Average air consumption	400 l/min	Weight	6,8 kg



235 1/2" M/C16
U02359285

Assortment with IMPACT hexagonal sockets in modular box

DESCRIPTION	ITEM/SIZE	PCS
Impact hexagonal sockets	235 1/2 M 10-12-13-14-15-16-17-18-19-21-22-24-27-30-32 mm	15
Lock pins	235 MCA/4-6	2
Safety rings	235 MDA/4-6	2
Impact extensions	236 1/2 M/125	1

16
PIECES

1"
2

↔ 375
↑ 80
mm ↘ 186



235 3/4" M/C8
U02359286

Assortment with short hexagonal impact sockets

DESCRIPTION	ITEM/SIZE	PCS
Impact hexagonal sockets	235 3/4" M 21-22-24-27-30-32-36-41 mm	8

8
PIECES

3"
4

↔ 375
↑ 80
mm ↘ 186

COMPRESSED AIR

10 m cable
Ø 8 mm



NEW

939 C
U09390003

3,9 kg mm ↔ 355
↑ 185
↙ 310

Air hose reel 8 mm

- Model with automatic hose rewind and stop device.
- Shockproof plastic body with swivel bracket for wall mounting.
- Suitable for outdoor use.
- Polyurethane/PVC hose.

TECHNICAL CHARACTERISTICS

Hose length	10 m
Internal hose diameter	8 mm
Maximum operating pressure	15 bar
Length of feeding hose	1,5 m
Output threaded male connecto	3/8"
Average air consumption	300 l/min@7bar

2006/42/CE
ISO EN 12100:2010

COMPRESSED AIR

16 m cable
Ø 10 mm



939 C1
U09390004

8 kg mm ↔ 450
↑ 230
↙ 400

Air hose reel 10 mm

- Model with automatic hose rewind with holding device
- Shock resistant plastic casing with swivel bracket for attachment to wall
- Can also be used outdoors
- Polyurethane/PVC hose

TECHNICAL CHARACTERISTICS

Hose length	16 m
Internal hose diameter	10 mm
Maximum operating pressure	15 bar
Length of feeding hose	1,5 m
Output threaded male connecto	3/8"
Average air consumption	450 l/min@7bar

2006/42/CE
ISO EN 12100:2010

COMPRESSED AIR

16 m cable
Ø 12,5 mm



NEW

939 C2
U09390005

10,6 kg mm ↔ 550
↑ 270
↙ 505

Air hose reel 12,5 mm

- Automatic hose rewind model with locking device
- Shockproof plastic body with swivel bracket for wall mounting
- Suitable for outdoor use
- Polyurethane hose/PVC

TECHNICAL CHARACTERISTICS

Hose length	16 m
Internal hose diameter	12,5 mm
Maximum operating pressure	15 bar
Length of feeding hose	1,5 m
Output threaded male connecto	3/8"
Average air consumption	800 l/min@7bar

2006/42/CE
ISO EN 12100:2010

ELECTRICITY 230V

NEW

**15 m cable
3G x 1,5 mm²**



939 E
U09390007

5 kg 355 mm 185 mm 310 mm

Cable reel

- Automatic cable rewind model with locking device
- Shockproof plastic body with swivel bracket for wall mounting
- 3G x 1.5mm² PVC cable
- Schuko plug and socket
- Rack cable locking device engageable every 50 cm

TECHNICAL CHARACTERISTICS

Hose length	15 m
Wound cable capacity	1,2 kW @230V
Unwound cable capacity	1,5 kW @230V
Protection level	IP 42

OIL AND WATER

NEW

**Hose 15 m
Ø 10 mm**



939 W
U09390006

15,6 kg 550 mm 270 mm 505 mm

Oil and water hose reel

- Automatic hose rewind model with locking device
- ABS spool and epoxy-painted steel bracket
- Black reinforced synthetic rubber hose EN857 1 SC
- Brass inlet fitting

TECHNICAL CHARACTERISTICS

Inlet fitting	3/8 F
Output threaded male connector	3/8 F girevole
Internal hose diameter	10 mm
Hose length	15 m
Maximum pressure	180 bar
Operating temperature	-15 ÷ 130 °C

NEW

**Tape 20 m
Width: 4 cm**



939 N
U09390008

4 kg 350 mm 290 mm 160 mm

Area delineation reel

- White/red striped polypropylene tape, 20 m length
- For creating temporary barriers and marking hazardous areas
- Automatic tape rewind model with locking device
- Shockproof plastic body with swivel bracket for wall mounting
- 180° adjustable bracket





IMPACT SOCKETS 235 MB



**10
PIECES**

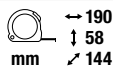

**22
PIECES**

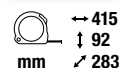

235 1/2" MB/C10

U02350530



Assortment with short hexagonal impact sockets

DESCRIPTION	ITEM/SIZE	PCS
Short impact hexagonal sockets	235 1/2" M 10-11-12-13-14-15-16-17-18-19	10

236 KE/C22

U02360900



Assortment with short hexagonal impact sockets, extension wrench and impact bits

DESCRIPTION	ITEM/SIZE	PCS
Short impact hexagonal sockets	235 1/2" MB 13-14-15-16-17-18-19	7
Bit-holder chain extension in Aluminium	236 KE 1/2"	1
Impact bits for hexagonal screws - 1/2" connection	687 E 5-6-8-10-12-14	6
Impact bits for TORX® screws - 1/2" connection	687 TX T25-T27-T30-T40-T45-T50-T55	7
Adapter for impact sockets	236 KEADP	1

**USE WITH RATCHET OR
IMPACT WRENCH**

236 K for sockets



YouTube



YouTube

236 KE for bits

**GREAT ACCESSIBILITY
HEAD DIMENSIONS AS A RATCHET*:**



39 mm

*Comparison with 1/2" ratchet.

**MINIMUM SIZE
DIRECT COUPLING FOR
IMPACT BITS.**



Integrated
spring steel ring.

236 K



Chain extension in Aluminium for sockets

CODE	□	L	H	📈
U02360700	1/2"	340 mm	39 mm	1,1 kg
U02360698	1/4"	260 mm	27 mm	300 g

236 KE



Bit-holder chain extension in Aluminium

CODE	□	⬡	L	H	📈
U02360705	1/2"	1/2"	340 mm	24 mm	1,1 kg
U02360710	1/4"	1/4"	260 mm	19 mm	300 g

AIR GRINDERS RANGE

**BODY AND HANDLE
IN ANTI-SLIP MATERIAL**

SAFETY SNAP LEVER

COLLET SIZE 6 mm



YouTube

**DOUBLE BEARING
SYSTEM FOR
LONGER LIFE**

**1/4" THREADED
CONNECTION**

**REAR AIR
EXHAUST**

30.000 Rpm



922 B1
U09220001

Straight grinder - 0.3 CV (220 W)

TECHNICAL CHARACTERISTICS

Average air consumption	76 l/min	Vibrations	2,42 m/s ²
Recommended air pressure	6,2 bar	Air inlet	1/4"
Sound level	84,8±3 dB(A)	Ø hose size	10 mm
Sound power	99,5±3 dB(A)	Weight	440 g

23.000 Rpm



922 BP1
U09220004

90° Angle grinder - 0.3 CV (220 W)

TECHNICAL CHARACTERISTICS

Average air consumption	76 l/min	Vibrations	4,54 m/s ²
Recommended air pressure	6,2 bar	Air inlet	1/4"
Sound level	85,9±3 dB(A)	Ø hose size	10 mm
Sound power	96,9±3 dB(A)	Weight	555 g

90°

28.000 Rpm



922 BL1
U09220003

Long anvil straight grinder - 0.3 CV (220 W)

TECHNICAL CHARACTERISTICS

Average air consumption	76 l/min	Vibrations	2,86 m/s ²
Recommended air pressure	6,2 bar	Air inlet	1/4"
Sound level	83,3±3 dB(A)	Ø hose size	10 mm
Sound power	94,3±3 dB(A)	Weight	664 g



Join our channel

@USAGexport

Tutorial video,
new products
and much more!

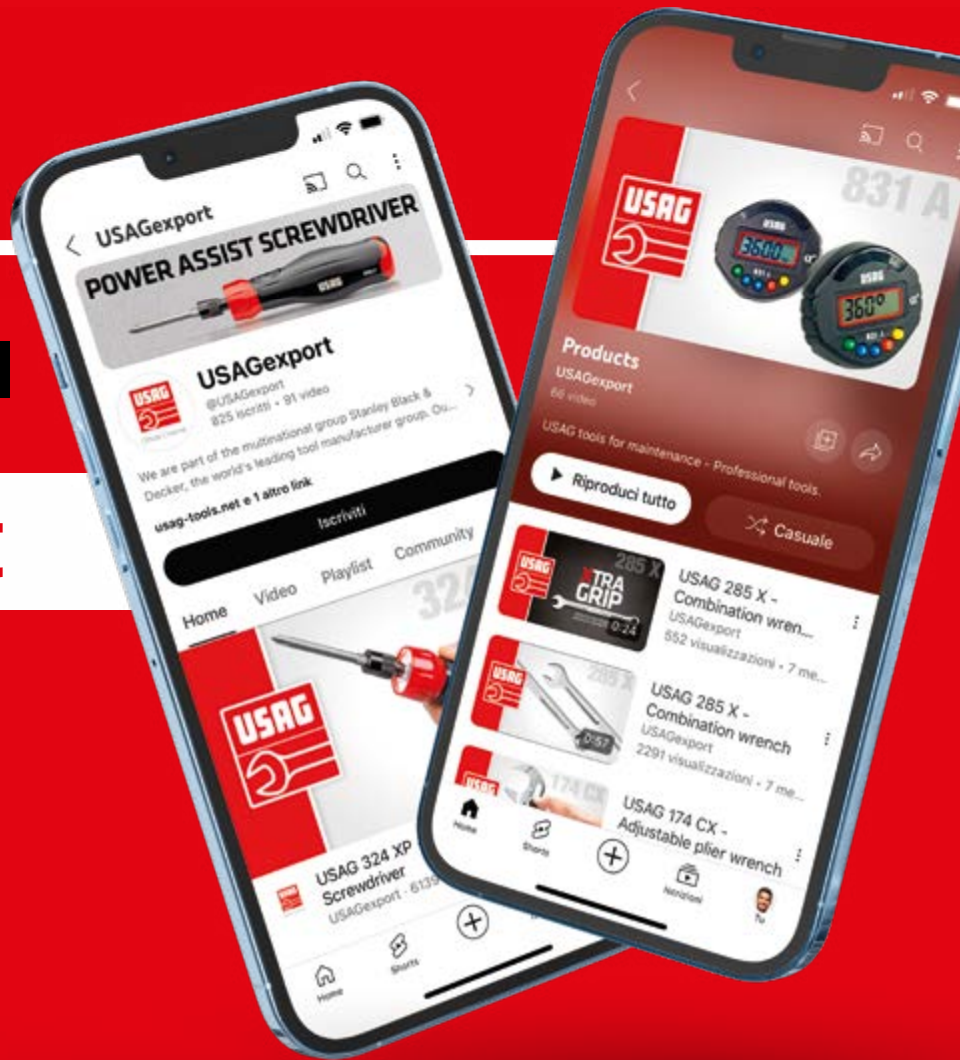

Do you need support from us?

Go to our website:



usag.it/en/contacts/support



Promotion valid till 31/03/2026 while stocks last.

The images shown in this catalogue are not binding.

Stanley Black & Decker italia S.r.l. reserves the right to change the technical characteristics of its products at any time.

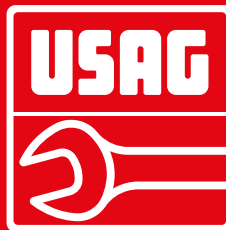

Stanley Black & Decker Italia S.r.l.

Via Volta, 3 - 21020 - Monvalle (VA)
Tel. +39 0332 790 111 - info.mv@usag.it

usag-tools.net

